

**DOCKETED**

<b>Docket Number:</b>	19-AB-2127
<b>Project Title:</b>	Implementation of AB 2127 Electric Vehicle Charging Infrastructure Assessments
<b>TN #:</b>	236237
<b>Document Title:</b>	Assembly Bill 2127 Electric Vehicle Charging Infrastructure Assessment (Staff Report)
<b>Description:</b>	This assessment examines charging needs to support California's plug-in electric vehicles in 2030. This staff draft will be revised with stakeholder input and the final version of this first biennial report will be adopted at an Energy Commission Business Meeting.
<b>Filer:</b>	Raja Ramesh
<b>Organization:</b>	California Energy Commission
<b>Submitter Role:</b>	Commission Staff
<b>Submission Date:</b>	1/7/2021 9:42:55 AM
<b>Docketed Date:</b>	1/7/2021



**CALIFORNIA  
ENERGY COMMISSION**



**CALIFORNIA  
natural  
resources  
AGENCY**

California Energy Commission

## **STAFF REPORT**

# **Assembly Bill 2127 Electric Vehicle Charging Infrastructure Assessment**

**Analyzing Charging Needs to Support  
Zero-Emission Vehicles in 2030**

**Gavin Newsom, Governor  
January 2021 | CEC-600-2021-001**





# California Energy Commission

Noel Crisostomo

Wendell Krell

Jeffrey Lu

Raja Ramesh

**Primary Authors**

Kiel Pratt

**Project Manager**

Charles Smith

**Office Manager**

**TRANSPORTATION POLICY AND ANALYSIS OFFICE**

Hannon Rasool

**Deputy Director**

**FUELS AND TRANSPORTATION DIVISION**

Drew Bohan

**Executive Director**

## **DISCLAIMER**

**Staff members of the California Energy Commission prepared this report. As such, it does not necessarily represent the views of the Energy Commission, its employees, or the State of California. The Energy Commission, the State of California, its employees, contractors and subcontractors make no warrant, express or implied, and assume no legal liability for the information in this report; nor does any party represent that the uses of this information will not infringe upon privately owned rights. This report has not been approved or disapproved by the Energy Commission nor has the Commission passed upon the accuracy or adequacy of the information in this report.**

## **ACKNOWLEDGEMENTS**

The following California Energy Commission staff members contributed to the development of this *Assembly Bill 2127 Electric Vehicle Charging Infrastructure Assessment*: Matt Alexander, Jennifer Allen, Aniss Bahreinian, Messay Betru, Kyle Corrigan, Jesse Gage, Tiffany Hoang, Madison Jarvis, Elizabeth John, Alex Lonsdale, Thanh Lopez, Bob McBride, Tim Olson, Mark Palmere, Mark Perry, Sharon Purewal, Shaun Ransom, Larry Rillera, Ben Wender, and Micah Wofford.

The authors appreciate the analytical expertise of these research collaborators: Eric Wood, Dong-Yeon Lee, Matteo Muratori, Ria Kontou, Nick Reinecke, and Yanbo Ge (National Renewable Energy Laboratory); Bin Wang, Cong Zhang, Fan Tong, and Doug Black (Lawrence Berkeley National Laboratory); Gil Tal, Alan Jenn, and Adam Davis (University of California at Davis); and coordination with the efforts of Siobhan Powell and Ram Rajagopal (Stanford University), Siddharth Sridhar and Michael Kintner-Meyer (Pacific Northwest National Laboratory), and Jason Harper (Argonne National Laboratory).

The authors value the ongoing interagency coordination on infrastructure efforts and the input and feedback from Carolyn Sisto, Audrey Neuman, Michael Truax, Ed Pike, and Sulekha Chattopadhyay (California Public Utilities Commission); Joshua Cunningham, Nicole Dolney, Kathy Jaw, Sara Forestieri, Fang Yan, Paul Arneja, Brandon Rose, Katherine Garrison, Ryan Hart, and Melanie Zauscher (California Air Resources Board); Janette Ramirez, Eric Fredericks, and Kalin Pacheco (Caltrans); and Ian Macmillan (South Coast Air Quality Management District).



# ABSTRACT

This inaugural *Assembly Bill (AB) 2127 Electric Vehicle Charging Infrastructure Assessment* examines charging needs to support California's plug-in electric vehicles (PEVs) in 2030. Under AB 2127, the Energy Commission is required to publish a biennial report on the charging needs of five million zero emission vehicles (ZEVs) by 2030. In September 2020, Governor Newsom issued Executive Order N-79-20, which directed the Energy Commission to update this assessment to support expanded ZEV adoption targets.

Executive Order B-48-18 set a goal of having 250,000 chargers (including 10,000 direct current fast chargers) by 2025. California has nearly 67,000 public and shared chargers installed, including over 5,000 direct current fast chargers, as of September 30, 2020. This report finds that an additional 121,000 are planned, leaving a gap of installations, 62,000 from the 250,000 charger goal.

For passenger vehicle charging in 2030, this report projects 968,000 chargers are needed to support 5 million PEVs, and 1.5 million to support the nearly 8 million PEVs required under the new Order. An additional 157,000 chargers are needed to support 180,000 medium- and heavy-duty vehicles needed in 2030.

A portfolio of charging solutions is needed to address site-specific real estate and grid constraints. To maximize grid integration, energy resilience, and ease of use, charging equipment hardware and software should use common connector and communication standards.

Charging businesses are evolving beyond a model of selling electricity, which alone may be insufficient for sustainable operations. Rather, innovative business models are prioritizing higher utilization, diversified revenues, and adaptation to local environments. This report outlines needs for continued government support and funding, increased private funding, and a flexible and scalable framework to accommodate the growing charging market.

**Keywords:** Charging, infrastructure, transportation electrification, electric vehicle, network planning

Please use the following citation for this report:

Crisostomo, Noel, Wendell Krell, Jeffrey Lu, and Raja Ramesh. January 2021. *Assembly Bill 2127 Electric Vehicle Charging Infrastructure Assessment: Analyzing Charging Needs to Support Zero-Emission Vehicles in 2030*. California Energy Commission. Publication Number: CEC-600-2021-001.





# TABLE OF CONTENTS

	Page
Acknowledgements .....	i
Abstract .....	iii
Table of Contents .....	v
List of Figures .....	vii
List of Tables.....	viii
Executive Summary .....	1
Light-Duty Vehicles Will Need Over 1.5 Million Shared Chargers by 2030 .....	1
Continued Public Support for Charger Deployment is Essential to Meet State ZEV Goals.....	2
Electrification of Medium- and Heavy-Duty Vehicles Is Accelerating .....	4
Charging Solutions Must Be Tailored to Local and Community Needs to Ensure ZEV Access for All Californians.....	5
Prioritize Charging Standards and Innovation .....	5
The Road Ahead .....	5
CHAPTER 1: Background .....	7
CHAPTER 2: Existing Charging Infrastructure .....	10
Charger Types and Definitions .....	10
Counting Chargers .....	11
Analysis Shows Gaps in Geographic Distribution of Chargers.....	12
CHAPTER 3: Current Transportation Trends .....	16
Transportation Greenhouse Gas Emissions Continue to Rise .....	16
Californians Are Driving More.....	17
Growing Demand and Charging Needs for Ride-Hailing Services .....	18
Light-Duty ZEV Sales Are Growing as Battery Costs Decline .....	20
Growing Electrification of the Medium- and Heavy-Duty Sectors.....	23
CHAPTER 4: Modeling California’s Charger Needs .....	26
Near-Term Gap in Charging Infrastructure .....	26
Shared and Public Charging Are Key To Enabling Electrification .....	26

EVI-Pro 2 .....	28
Modeling Results .....	30
Policy Implications.....	33
EVI-RoadTrip.....	35
Modeling Results .....	35
Policy Implications.....	38
WIRED.....	39
Modeling Results .....	39
Future Refinements and Policy Implications.....	40
HEVI-LOAD .....	41
Modeling Results .....	43
Future Refinements and Policy Implications.....	44
EVSE Deployment and Grid Evaluation Model .....	44
Modeling Results .....	45
Policy Implications.....	48
Summary of Quantitative Modeling .....	48
CHAPTER 5: Meeting California’s Technological Charging Infrastructure Needs .....	50
Pursue Greater Vehicle-Grid Integration to Support Grid Reliability, Provide Energy Resiliency, and Minimize Cost.....	50
Smart Charging .....	50
Bidirectional Charging.....	52
Prioritize Standardized and Interoperable Charger Connectors and Communications.....	53
Standardizing Charger Connectors.....	54
Standardizing Charger Communication Protocols .....	57
CHAPTER 6: Planning for California’s Local and Community Charging Infrastructure Needs ...	61
Tailor Charging Solutions So That Their Form Factors Match Local Needs .....	61
Use Community-Centric Planning to Serve Local and Community Needs and Foster Equitable Outcomes.....	62
Building Codes are a Crucial Policy Tool to Deploy Sufficient Charging Infrastructure .....	64
Recognize and Prepare for Greater Complexities With Medium- and Heavy-Duty Infrastructure Planning.....	65
Continue Streamlining Local Permitting Ordinances.....	68
Publicly Owned Utilities Should Continue to Enhance Their Preparedness for Electrification	69

Develop Workforce to Support Charging Infrastructure Deployment .....	70
CHAPTER 7: Financing California’s Charging Infrastructure Needs.....	73
Continued Public Support for Charger Deployment is Essential to Meet State ZEV Goals.....	73
Mandates and Infrastructure Incentives have Driven Charging Infrastructure Growth .....	75
Promoting Private Investment Will Lead to Self-Sustaining Industry .....	80
Exploring Innovative Programs, Financial Instruments, and Process Improvements Could Increase Private Sector Investment .....	84
CHAPTER 8: The Road Ahead .....	91
GLOSSARY .....	93
APPENDIX A: List of Related Public Workshops.....	A-1
APPENDIX B: EVI-Pro 2 Inputs and Parameters.....	B-1
APPENDIX C: EVI-Pro 2 Alternative Futures Scenarios.....	C-1

## **LIST OF FIGURES**

	Page
Figure 1: Projected 2030 Charger Counts to Support 5 Million and 8 Million Light-Duty Zero-Emission Vehicles .....	2
Figure 2: Projected Statewide Power for Unmanaged Light-Duty Charging on a Typical 2030 Weekday.....	4
Figure 3: CEC’s Analyses Cover Multiple Facets of Charging Infrastructure.....	9
Figure 4: Installed and Projected Charger Counts Compared with Charger Needs for 1.5 million ZEVs in 2025 and 5 million ZEVs in 2030 .....	12
Figure 5: Population Density, PEV Density, and Public Chargers by County .....	13
Figure 6: Public Charger Counts by Census Tract Population Density.....	14
Figure 7: Public Level 2 and DC Fast Chargers Per Capita by Income .....	15
Figure 8: Transportation-Related Emissions Accounted for More Than Half of the State’s GHG Emissions in 2018.....	17
Figure 9: California Light-Duty Vehicle Miles Traveled (in Billions) .....	18
Figure 10: Daily Charging Profile of TNC and Non-TNC Drivers in Los Angeles.....	20
Figure 11: ZEV Adoption Trajectories .....	21
Figure 12: U.S. SUV Segment Price and Share of Battery Cost.....	22
Figure 13: Quarterly ZEV Sales in California .....	23

Figure 14: Projected 2030 Weekday Statewide PEV Charging Load .....	33
Figure 15: Station Locations to Support 2030 Interregional Electric Travel .....	37
Figure 16: Projected 2030 Load Curve for Interregional DC Fast Charging .....	38
Figure 17: Chargers Needed to Support TNC PEVs (2023-2030).....	40
Figure 18: Chargers Needed to Support TNC PEVs in 2030 by Region .....	40
Figure 19: Projected On-Road Medium- and Heavy-Duty Vehicle Charging Load.....	44
Figure 20: EDGE Capacity Analysis and Data Gaps.....	47
Figure 21: Grid-Integrated Charging Equipment Design Archetype.....	60
Figure 22: Examples of Different Charger Form Factors Based on Local Environment .....	62
Figure 23: Key Occupations for Electric Vehicle Charging Infrastructure .....	71
Figure 24: Charging “Beyond the Grid” .....	79
Figure 25: Serving a Broader Driver Market .....	79
Figure 26: Challenging the Premise That Networks Must “Charge for Charging” .....	80
Figure 27: Cost of Enabled Charging Equation.....	87
Figure B-1: BEV Population Breakdown by Vehicle Classification for Baseline Scenario (5 Million ZEVs) .....	B-2
Figure B-2: PHEV Population Breakdown by Vehicle Classification for Baseline Scenario (5 Million ZEVs) .....	B-3
Figure C-1: Projected 2030 Weekday Load Curve for the Unconstrained Alternative Future ..	C-3
Figure C-2: Projected 2030 Weekday Load Curve for the Gas Station Model Alternative Future .....	C-4
Figure C-3: Projected 2030 Weekday Load Curve for the Level 1 Charging Alternative Future ...	C-5
Figure C-4: Projected 2030 Weekday Load Curve for the PHEV eVMT Maximization Alternative Future .....	C-6

## LIST OF TABLES

	Page
Table 1: Types of Chargers.....	10
Table 2: Definitions of Common Charging Terms .....	11
Table 3: Statewide Counts of Level 2 and DC Fast Chargers, and Projected Charger Gap for 1.5 million EVs by 2025 and 5 million by 2030 .....	12

Table 4: Summary of CEC Charging Infrastructure Quantitative Analyses .....	28
Table 5: Comparison of Primary Input Parameters for EVI-Pro 1 and 2.....	29
Table 6: Projected Chargers Needed to Support Intra-Regional Travel in 2030.....	31
Table 7: DC Fast Chargers Needed to Support 2030 Interregional Electric Travel .....	36
Table 8: Comparison of Primary Input Parameters for HEVI-LOAD .....	43
Table 9: EDGE Domain Data Sources and Evaluation Criteria.....	45
Table 10: Summary of Quantitative Modeling Preliminary Results .....	49
Table 11: Existing and Upcoming Charging Connector Standards.....	56
Table B-1: BEV/PHEV Shares for 5 Million ZEVs in EVI-Pro 2.....	B-1
Table B-2: Electric Range for BEVs by Vehicle Classification and Simulation Year.....	B-3
Table B-3: Electric Range for PHEVs by Vehicle Classification and Simulation Year .....	B-4
Table B-4: Battery Size for BEVs by Vehicle Classification and Simulation Year .....	B-4
Table B-5: Battery Size for PHEVs by Vehicle Classification and Simulation Year.....	B-5
Table B-6: Residential AC Charge Power for BEVs by Vehicle Classification and Simulation Year .....	B-5
Table B-7: DC Charge Power for BEVs by Vehicle Classification and Simulation Year.....	B-6
Table B-8: AC Charge Power for PHEVs by Vehicle Classification and Simulation Year .....	B-6
Table C-1: Summary of Alternative Future Scenarios .....	C-1
Table C-2: Alternative Future Network Results for 5 Million ZEVs in 2030 .....	C-1

# Executive Summary

On September 23, 2020, Governor Gavin Newsom signed Executive Order N-79-20, setting the following targets for zero-emission vehicles (ZEVs):

- By 2035, 100 percent ZEV sales for new passenger vehicles and 100% ZEV operations for drayage trucks and off-road vehicles and equipment.
- By 2045, 100 percent ZEV operations for medium- and heavy-duty vehicles, where feasible.

With transportation accounting for over 50 percent of the state's greenhouse gas (GHG) emissions, over 80 percent of smog-forming nitrogen oxide pollution, and 95 percent of toxic diesel particulate matter, the full transition to ZEVs is an important step toward carbon neutrality by 2045 and will benefit public health and air quality.

Assembly Bill 2127 (Ting, Chapter 365, Statutes of 2018) requires the California Energy Commission (CEC) to prepare a statewide assessment of the charging infrastructure needed to achieve the goal of 5 million ZEVs on the road by 2030. Executive Order N-79-20 directed the CEC to expand this assessment to support the levels of electric vehicle adoption required by the Order.

Early analysis from the California Air Resources Board (CARB) estimates that 8 million light-duty ZEVs and 180,000 medium- and heavy-duty ZEVs will be needed in 2030 to meet the new Order. For passenger vehicle charging in 2030, this report projects that 968,000 chargers are needed to support 5 million ZEVs and 1.5 million chargers are needed to support 8 million ZEVs. For medium- and heavy-duty charging in 2030, preliminary analysis suggests that 157,000 chargers are needed to support 180,000 ZEVs.

Future reports will reassess charging infrastructure needs for 2030 and potentially project longer-term needs in 2035 and 2045, under Executive Order N-79-20.

Informed by data and input from stakeholders, this report identifies trends and market, technical, and policy solutions that would advance transportation electrification to benefit all Californians. This report outlines a vision where charging is accessible, smart, widespread, and easier than a trip to the gas station.

## **Light-Duty Vehicles Will Need Over 1.5 Million Shared Chargers by 2030**

California's cumulative ZEV sales reached 763,816 in September 2020, including nearly 59 percent battery-electric vehicles (BEVs), nearly 40 percent plug-in hybrid vehicles (PHEVs), and just over one percent hydrogen fuel cell electric vehicles (FCEVs). Industry forecasts from Bloomberg New Energy Finance find that BEVs may achieve purchase cost parity with internal combustion engine counterparts as early as 2022 in select vehicle segments. With vehicle costs decreasing and consumer acceptance growing, access to convenient charging

infrastructure is critical to generate the exponential growth needed to achieve 100 percent ZEV passenger vehicle sales by 2035.

As of September 30, 2020, there are nearly 67,000 public and shared private chargers available across the state. This report finds that an additional 121,000 chargers are planned (through state grants, approved utility investments, and settlement agreements), bringing the total to 188,000 chargers. To meet the 2025 goal of 250,000 public and shared chargers, the state needs about 62,000 more than are already installed or planned.

Modeling results in this report project that the state will need over 1.5 million public and shared private chargers in 2030 to support the number of light-duty vehicles needed to achieve the goals of the Executive Order N-79-20. Figure 1 illustrates the projected breakdown of charger type and count; green bars indicate the charger need for 5 million ZEVs, blue bars represent the additional charger need for 8 million ZEVs, and text labels at the rightmost end of each bar indicate the total charger need for 8 million ZEVs.

**Figure 1: Projected 2030 Charger Counts to Support 5 Million and 8 Million Light-Duty Zero-Emission Vehicles**

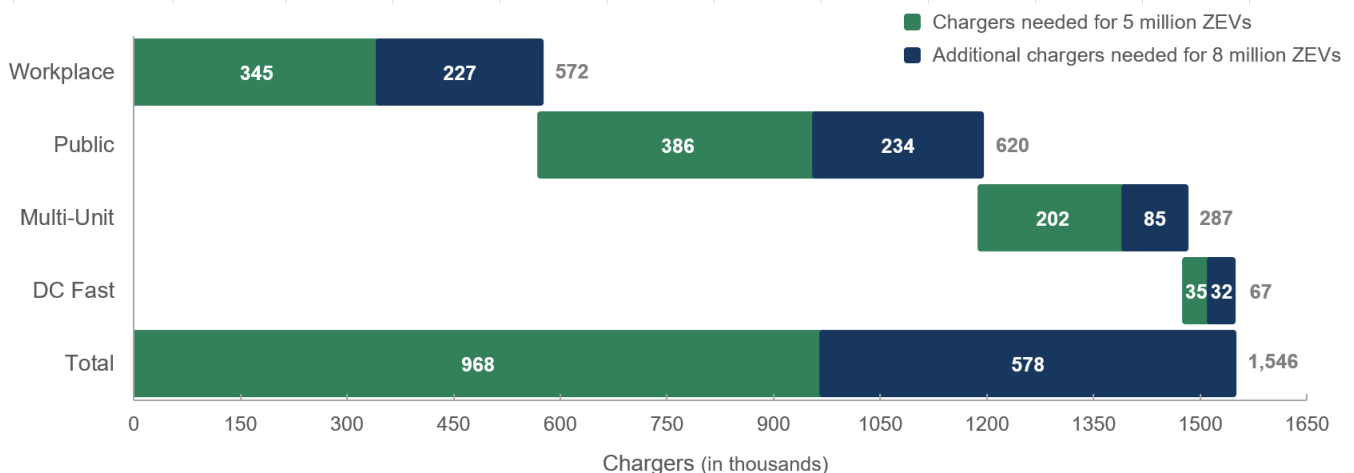

**Models project that California will need 968,000 shared private and public chargers in 2030 to support 5 million ZEVs, and over 1.5 million chargers to support 8 million ZEVs. Counts for chargers at workplaces, public destinations, and multi-unit dwellings generally indicate the number of Level 2 chargers needed. In some cases, Level 1 chargers may be sufficient at select public destinations primarily serving transportation network company vehicles and at select multi-unit dwellings. These values do not include chargers at single family residences.**

Source: CEC and National Renewable Energy Laboratory

## **Continued Public Support for Charger Deployment is Essential to Meet State ZEV Goals**

Continued growth in the PEV market will depend on driver confidence in charging infrastructure. Widely available charging will reduce range anxiety and give consumers confidence that PEVs are as convenient to fuel as conventional vehicles. The state must

continue to invest in charging infrastructure in order to achieve its ZEV goals. The immediate need is great, as demonstrated by the sheer number of chargers needed by 2030. The CEC's California Electric Vehicle Infrastructure Project (CALeVIP), which provides incentives for the purchase and installation of public chargers throughout California, is oversubscribed by hundreds of millions of dollars. Over the course of the project, applicants have requested more than \$300 million in rebates, but only about one third of those could be funded with available CEC and partner funds. While public investment will fall as PEV numbers increase and the private market becomes financially viable, significant public investment is needed now.

Electricity sales alone may not be enough to maintain sustainable business operations or cover capital costs for planning and constructing charging stations. Many companies have introduced or are exploring models that include complementary revenue streams, for example, through aggregated grid services, integration with local retail and marketing, or subscription-based business models. Public investments in charging infrastructure, including through CALeVIP, will remain critical to encouraging continued market experimentation, growth, and maturation. Public investments have already attracted large amounts of private follow-up capital. Policy makers can encourage greater private investment and business model innovation by exploring financing mechanisms that offer incentives for high charger utilization, diverse revenue streams, reduced charger costs, and minimization of grid upgrades.

## **The State Must Seek to Align PEV Charging with Renewable Energy Generation**

Charging millions of PEVs will introduce significant new load onto the electric grid. Without charging management strategies beyond time of use rates, CEC models project that electricity consumption in 2030 from light-duty vehicle charging will reach roughly 3,600 megawatts (MW) around midnight on a typical weekday, increasing electricity demand by up to 15 percent (Figure 2). These preliminary results suggest that policies are needed to better align PEV charging demand with daytime solar generation. To fully realize the economic, air quality, and climate benefits of electrification, California must pursue greater vehicle-grid integration to ensure that charging is better aligned with clean, renewable electricity without sacrificing driver convenience.



**Figure 2: Projected Statewide Power for Unmanaged Light-Duty Charging on a Typical 2030 Weekday**

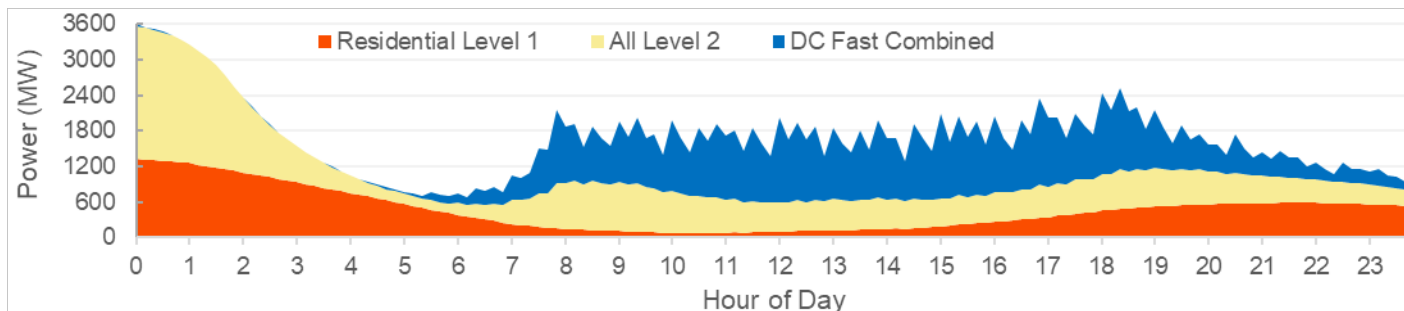

**Without charging management strategies beyond time of use rates, peak charging demand in 2030 will not align with daytime solar generation and instead may increase overall electricity demand by 15 percent at midnight. DC fast charging, which accounts for a portion of charging demand, occurs mostly during the day.**

Source: CEC and National Renewable Energy Laboratory

## Electrification of Medium- and Heavy-Duty Vehicles Is Accelerating

While medium- and heavy-duty vehicles and equipment are critical to California’s businesses, freight operations, and transit systems, they are responsible for 68 percent of the nitrogen oxide emissions and 90 percent of the diesel soot statewide. Electrifying the state’s medium- and heavy-duty sector will be crucial to meeting the state’s climate goals and improving air quality, especially in disadvantaged communities.

In the next five years, medium- and heavy-duty vehicles, such as delivery vans, class 8 trucks, and cargo handling equipment, will rapidly electrify due to market developments, regional air quality implementation plans, and state ZEV goals. While private light-duty vehicles typically see extended periods of downtime and generally have flexible charging patterns, medium- and heavy-duty vehicles tend to adhere to rigid and demanding operating schedules, making infrastructure planning for these vehicles unique. While set operating schedules may ease infrastructure planning and present opportunities for vehicle-grid integration, less downtime and higher electricity draws also present challenges.

CARB’s Draft 2020 Mobile Source Strategy projects the state will need 180,000 medium- and heavy-duty ZEVs in 2030 to achieve state climate and air quality goals and comply with Executive Order N-79-20. Preliminary modeling suggests 157,000 DC fast chargers will be needed to power these vehicles, of which 141,000 are 50 kW and 16,000 are 350 kW.

Although there is significant variation in energy demand timing among various vehicle types, this charging network corresponds with a load in excess of 2,000 MW around 5 p.m. on a typical weekday, highlighting the importance of concerted effort to manage load. Among off-road applications, significant infrastructure planning and investment is needed to support near-

term electrification of transport refrigeration units, cargo-handling equipment, and airport ground-support equipment.

## **Charging Solutions Must Be Tailored to Local and Community Needs to Ensure ZEV Access for All Californians**

While this report provides a high-level view of the infrastructure required to support California's ZEV future, charger deployment projects must be thoughtfully tailored to local needs. Effective charging solutions depend greatly on community needs, land use, space constraints, grid capacity, vehicle duty cycles, and other factors. Simply put, there is no one-size-fits-all solution for how charging should fit into the built environment. Planning charging infrastructure for medium- and heavy-duty vehicles introduces additional complexities given the broad range of vehicle uses and often-inflexible operating patterns.

Historically, transportation planning and projects have insufficiently considered the needs of the local community, particularly low-income and disadvantaged communities suffering disproportionate health impacts. To ensure the benefits of electrification are equitably distributed, policy makers must involve communities in identifying and planning high quality charging solutions that address community transportation needs and yield direct local benefits, including through tools such as participatory budgeting, inclusive community outreach, and community-centric planning.

Policy makers and electric vehicle stakeholders recognize that electrifying California's diverse mobility landscape requires solutions fitted to local constraints and needs, and effective infrastructure deployment requires various charging solutions and metrics. Charger funding programs should include those that can address grid upgrades, improve resiliency, enable higher charger utilization, or are well-suited to particular built environments.

## **Prioritize Charging Standards and Innovation**

Charger connectors and communication protocols, which determine whether a vehicle can charge when it arrives at a charging station, remain fragmented across all PEV sectors. DC fast charging connectors for passenger cars are split among three designs, and lack of connector standardization is even more prevalent among medium- and heavy-duty vehicles. Encouraging greater standardization of charging connectors promotes greater driver convenience and helps ensure that chargers installed today are not stranded in the future. Beyond the physical connector, prioritizing chargers which speak a common "language" with vehicles ensures chargers and vehicles can exchange the information necessary to automatically align charging with surplus renewable energy generation, enable plug-in vehicles to power homes and businesses during outages, and streamline the charging experience.

## **The Road Ahead**

Widespread, accessible, and convenient charging infrastructure is critical to transportation electrification and California's ability to address climate change and air pollution. The state will need over 1.5 million public and shared chargers by 2030, necessitating significant public

support and investment. Industry, working closely with the CEC, state agencies, and local governments, must quickly close the gap to provide drivers and fleets confidence that their mobility needs can be served by electric vehicles.

This report identifies several actions to support the widespread deployment of charging infrastructure:

- Continue public support for charger deployment, using public funds to leverage private funds, and eventually transition to a self-sustaining private market.
- Continue quantitative modeling efforts to project the quantities, locations, and load curves of chargers needed to meet statewide travel demand.
- Support innovative charging solutions and financing mechanisms.
- Support local efforts to prepare for transportation electrification.
- Ensure equitable distribution of charger deployment throughout the state.
- Align charging with renewable generation and grid needs.
- Prioritize standardized charger connectors and communications protocols.

# CHAPTER 1:

## Background

---

Despite progress reducing statewide greenhouse gas (GHG) emissions, California's transportation-related emissions now contribute more than half of the state's GHGs and emissions have been trending up since 2012. Transportation is a major source of the state's air pollution, contributing nearly 80 percent of smog-forming nitrogen oxides (NOx) and 95% of toxic diesel particulate matter.<sup>1</sup> To achieve the state's long-term air quality and GHG emissions goals, California must rapidly transition toward the widespread use of zero-emission vehicles (ZEVs) powered by clean energy. In support of this transition, in September 2020, Governor Gavin Newsom issued Executive Order N-79-20,<sup>2</sup> which calls for:

- All in-state sales of new passenger cars and trucks to be zero-emission by 2035.
- All drayage trucks operating in the state to be zero-emission by 2035.
- All medium- and heavy-duty vehicles operating in the state to be zero-emission by 2045, where feasible.
- All off-road vehicles and equipment to be zero-emission by 2035.

Preceding N-79-20, former Governor Edmund G. Brown Jr. issued Executive Order B-48-18,<sup>3</sup> which directed California to install 250,000 electric vehicle chargers, including 10,000 direct current (DC) fast chargers, to support 1.5 million ZEVs statewide by 2025. B-48-18 further established a target of 5 million ZEVs statewide by 2030. In 2018, Assembly Bill (AB) 2127<sup>4</sup> codified this 2030 ZEV target and tasked the California Energy Commission (CEC) with preparing biennial assessments of the charging infrastructure needed to meet these goals. While vehicles fueled by electricity or hydrogen are considered ZEVs, these assessments focus

---

1 California Energy Commission staff. 2019. [2019 Integrated Energy Policy Report](#). California Energy Commission. Publication Number: CEC-100-2019-001-CMF. Available at <https://www.energy.ca.gov/data-reports/reports/integrated-energy-policy-report/2019-integrated-energy-policy-report>.

2 Governor Gavin Newsom. [Executive Order N-79-20](#). Issued September 23, 2020. <https://www.gov.ca.gov/wp-content/uploads/2020/09/9.23.20-EO-N-79-20-text.pdf>.

3 Governor Edmund G. Brown, Jr. [Executive Order B-48-18](#). Issued January 26, 2018. <https://www.ca.gov/archive/gov39/2018/01/26/governor-brown-takes-action-to-increase-zero-emission-vehicles-fund-new-climate-investments/index.html>.

4 [Assembly Bill 2127 \(Ting\), Statutes of 2018, Chapter 365](#). [https://leginfo.legislature.ca.gov/faces/billTextClient.xhtml?bill\\_id=201720180AB2127](https://leginfo.legislature.ca.gov/faces/billTextClient.xhtml?bill_id=201720180AB2127).

exclusively on plug-in electric vehicles (PEVs), which include battery-electric vehicles (BEVs) and plug-in hybrid electric vehicles (PHEVs).

As directed by AB 2127, this document examines existing and future charging infrastructure needs throughout California, including the chargers, make-ready<sup>5</sup> electrical equipment, supporting hardware and software, and other programs for on-road and off-road vehicle categories. In assembling this analysis, CEC staff regularly sought input from stakeholders, including state agencies, utilities, transit agencies, charging infrastructure companies, environmental groups, and automakers.<sup>6</sup>

This report discusses several analyses of California's existing chargers, trends affecting charger deployment, and quantitative modeling of projected charger demand. It outlines several actions to ensure that charging is accessible, convenient, and available to meet the needs of all Californians. Figure 3 illustrates the breadth of this assessment, with vehicle categories spanning the horizontal axis in different colors and areas of analysis spanning the vertical axis. Specific CEC analyses are shown in the colored boxes with on-road light-duty vehicles in blue, medium- and heavy-duty vehicles in red, and off-road, port, and airport electrification applications in green.

---

5 "Make-ready" refers to the electrical infrastructure required to operate a charger, such as transformers or wiring.

6 Appendix A includes a list of relevant public workshops.

**Figure 3: CEC’s Analyses Cover Multiple Facets of Charging Infrastructure**

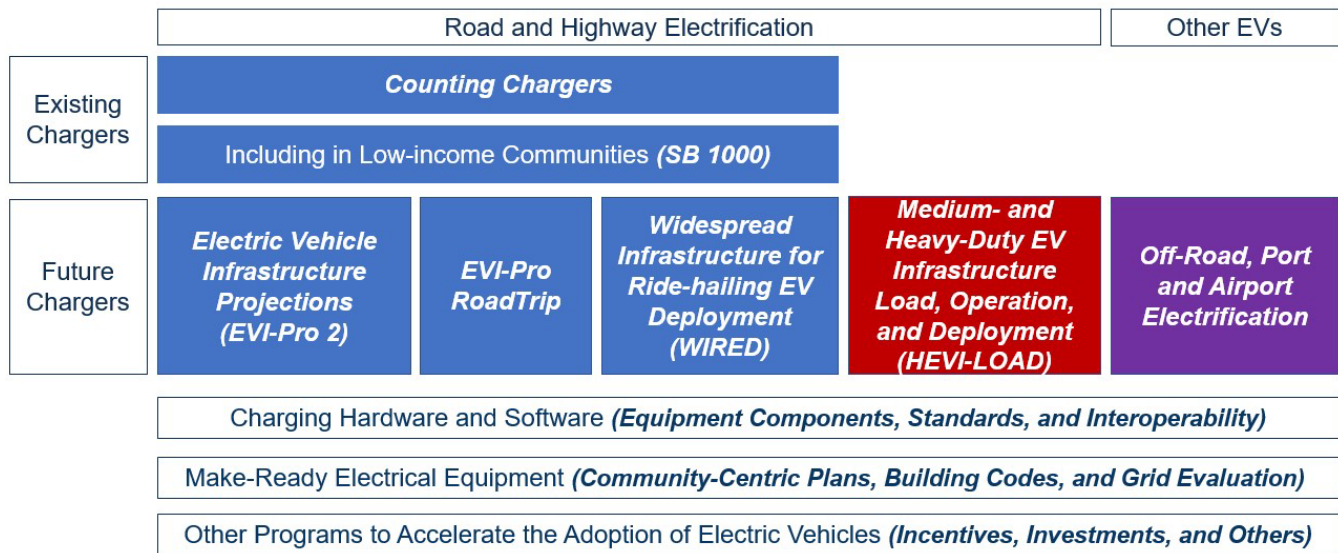

**AB 2127 directs the CEC to examine existing and future charging infrastructure needs, which includes the chargers, hardware and software, make-ready electrical equipment, and other programs to accelerate the adoption of electric vehicles for light-, medium-, and heavy-duty vehicles operating on roads and highways, as well as off-road, port, and airport electrification applications. CEC has several concurrent analysis and modeling efforts that cover these identified areas.**

Source: CEC

# CHAPTER 2:

## Existing Charging Infrastructure

---

### Charger Types and Definitions

Chargers, sometimes referred to as electric vehicle supply equipment (EVSE), are manufactured appliances that safely deliver electricity to charge a PEV. As summarized in Table 1, light-duty PEVs use primarily three types of charging systems: Level 1, Level 2, and DC fast charging. Level 1 and Level 2 chargers deliver alternating current (AC) electricity to the vehicle and use the Society of Automotive Engineering (SAE) J1772 standard connector. While all PEVs can use the SAE J1772 connector,<sup>7</sup> not all have a separate charging port compatible with DC fast charging. DC fast chargers deliver DC electricity to the vehicle. There are three types of connectors used for DC fast charging in the North American market: CHAdeMO, Combined Charging System (CCS), and Tesla. The charging inlet of a PEV determines the type of DC fast charging connector the vehicle can use.

**Table 1: Types of Chargers**

	Level 1	Level 2	DC Fast Charger
<b>Voltage</b>	120 Volts AC	208-240 Volts AC	50-1000 Volts DC
<b>Maximum power output in kilowatts (kW)</b>	1.9 kW	19.2 kW	450 kW
<b>Typical added range per hour of charging*</b>	~4 miles at 1.44 kW	~23 miles at 7.2 kW	~90 miles in 30 mins at 55 kW ~204 miles in 30 mins at 150 kW

\* Range estimates based on a 110 MPGe vehicle

Source: CEC, National Renewable Energy Laboratory, CharIN

When discussing chargers, the CEC uses specific nomenclature to avoid confusion between common terms such as charger and charging station. These definitions are summarized in Table 2.

---

<sup>7</sup> Tesla vehicles require an adapter supplied at purchase to use the J1772 connector.

**Table 2: Definitions of Common Charging Terms**

<b>Charger</b>	A manufactured appliance that delivers electricity to charge a PEV; also called “EVSE”.
<b>Connector</b>	A physical socket with a specified pin configuration. A charger may have one or multiple connectors.
<b>Charging Station</b>	A charging station is a physical address where one or more chargers are available for use. A charging station can be public, shared private, or private.
<b>Public</b>	A public charging station has parking space(s) designated by a property owner or lessee to be available to and accessible by the public for any period.
<b>Shared Private</b>	A shared private charging station has parking space(s) designated by a property owner or lessee to be available to and accessible by employees, tenants, visitors, and/or residents. Parking spaces are not dedicated to individual drivers or vehicles.
<b>Private</b>	A private charging station has parking space(s) that are privately owned and operated, often dedicated for a specific driver or vehicle (for example, a charger installed in the garage of a single-family home).

Source: CEC

## Counting Chargers

The CEC gathers statewide counts of light-duty shared private chargers through quarterly voluntary surveys with California's electric vehicle service providers (EVSPs), utilities, and public agencies. CEC staff aggregates charger counts from the surveys with public charger counts from the Alternative Fuels Data Center database to determine progress toward achieving the state's goal of 250,000 public and shared private chargers by 2025. These counts do not categorize chargers by market segment (workplace, public, fleet, and so forth) or include dedicated private chargers such as those installed for personal use at single-family homes. As shown in Figure 4 and Table 3, California has about 67,000 public and shared private chargers as of September 30, 2020.

In addition to tallying deployed chargers, Figure 4 and Table 3 also indicate the number of projected charger installations that will occur through 2025 based on funding allocated through state programs, ratepayer funds, and settlement agreements. By combining the existing and projected charger counts, the CEC estimates that the state will need an additional 61,000 Level 2 chargers and 500 DC fast chargers to achieve the 2025 goal of 250,000 chargers, of which 10,000 are DC fast chargers. Deployment of Level 2 chargers lags more significantly, with the 61,000-charger gap translating to around 25 percent of the 2025 goal, whereas the DC fast charger gap is only around 5 percent of the respective 2025 goal.

Finally, Figure 4 and Table 3 also show the gap between the projected number of chargers in 2025 and the projected charger need for five million ZEVs in 2030. CEC models (discussed in Chapter 4) project that the state will need between 923,000 and 1.01 million public and shared private chargers at public destinations, workplaces, and multi-unit dwellings (MUDs) in 2030, with an average projection of 968,000 chargers. Based on these estimates, the state will need an additional 780,000 chargers beyond the current 2025 projection to meet projected 2030 charging needs.



**Figure 4: Installed and Projected Charger Counts Compared with Charger Needs for 1.5 million ZEVs in 2025 and 5 million ZEVs in 2030**

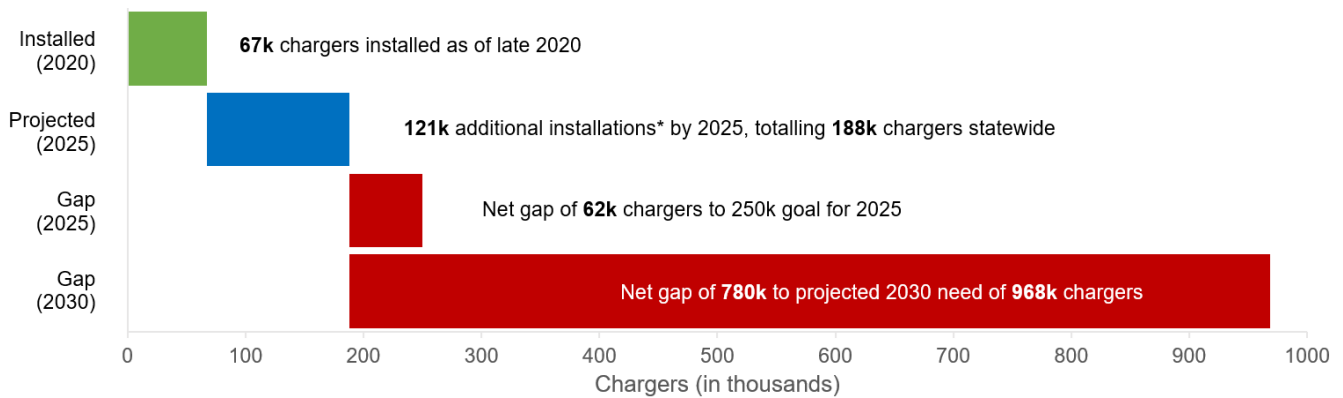

**\* Based on allocated funding through 2025 as of September 2020**

Source: CEC and National Renewable Energy Laboratory

**Table 3: Statewide Counts of Level 2 and DC Fast Chargers, and Projected Charger Gap for 1.5 million EVs by 2025 and 5 million by 2030**

	Level 2 Chargers	DC Fast Chargers	Level 2 + DC
Public (2020)	22,531	4,818	27,349
Shared Private (2020)	38,949	550	39,499
Total Installed (2020)	61,480	5,368	66,848
Projected Additional Installations (2025)*	117,316	4,091	121,407
Projected Total (2025)*	178,796	9,459	188,255
Gap to 2025 Need	61,204	541	61,745
Gap to 2030 Need	754,204**	26,014	780,218

**\* Based on allocated funding through 2025 as of September 2020**

**\*\* May include Level 1 charging at MUDs**

Source: CEC and National Renewable Energy Laboratory

### Analysis Shows Gaps in Geographic Distribution of Chargers

Senate Bill 1000 directs the CEC to assess whether light-duty charging infrastructure is disproportionately distributed with respect to population density, geographical area, or income, including low-, middle-, and high-income levels. Such findings are discussed in greater detail in

*California Electric Vehicle Infrastructure Deployment Assessment: Senate Bill 1000 Report.*<sup>8</sup> Results will inform future Clean Transportation Program investments.

Preliminary county-level analysis indicates that chargers are generally deployed where there are high concentrations of people and PEVs, as shown in Figure 5. Regionally, air district-level analysis indicates that nearly three-quarters of public Level 2 chargers and more than half of public DC fast chargers statewide are contained in the South Coast and Bay Area Air Quality Management Districts alone.

**Figure 5: Population Density, PEV Density, and Public Chargers by County**

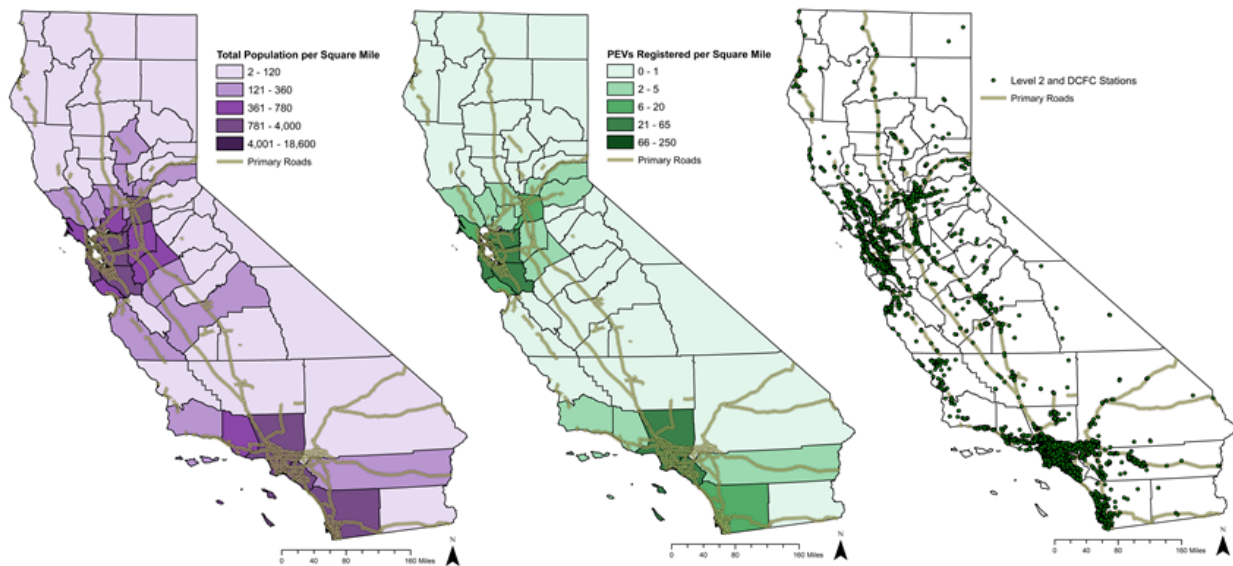

**At the county level, existing chargers are generally found in areas with high concentrations of people and PEVs, particularly those in the Bay Area and South Coast.**

Source: CEC

At a finer scale, however, factors other than population and PEV density appear to play a larger role in existing charger distribution. Staff evaluated charger deployment by census tract population density for a neighborhood-level analysis; at this census tract level, more chargers appear in census tracts with low population density than in tracts with high population density, as shown in Figure 6. Land use and area contribute to this observation. Staff found that census tracts with high population density generally cover less area and are predominantly

---

<sup>8</sup> Hoang, Tiffany. 2020. [California Electric Vehicle Infrastructure Deployment Assessment: Senate Bill 1000 Report](#). California Energy Commission. Publication Number: CEC-600-2020-153.

residential. Chargers are mostly absent or low in these dense urban residential census tracts. The census tracts neighboring these, with large commercial areas and more roads, generally contain more public chargers. On the other hand, census tracts with low population densities and high numbers of chargers are usually larger tracts that contain land uses like large commercial areas and airports.

**Figure 6: Public Charger Counts by Census Tract Population Density**

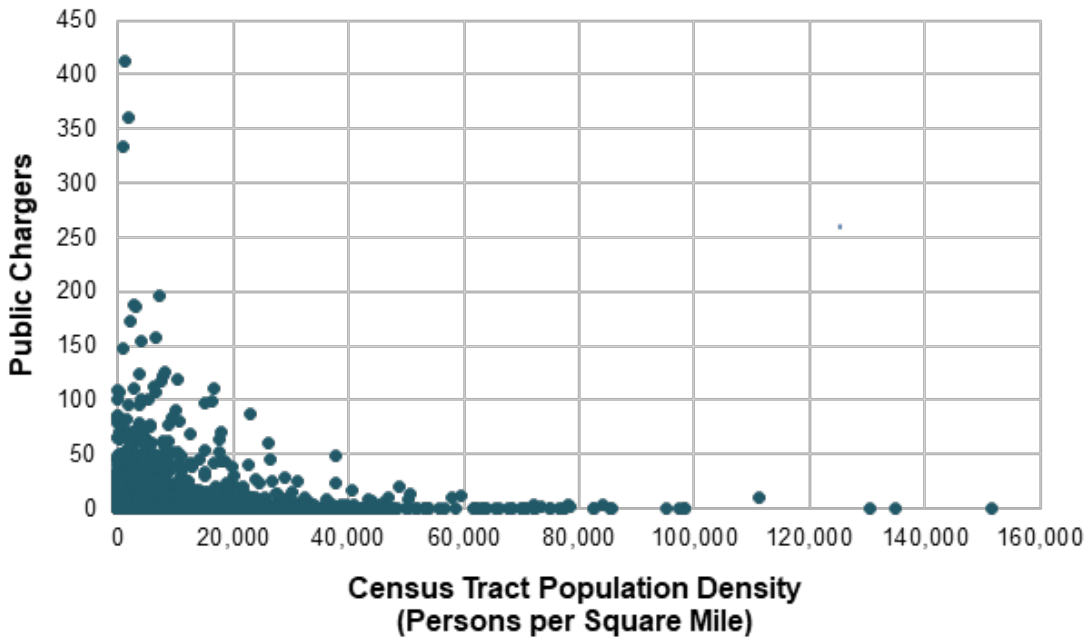

**More chargers appear in census tracts with low population density than in high-population-density tracts. Staff found that chargers are mostly absent or rare in dense urban residential tracts.**

Source: CEC

Staff also found differences in public Level 2 and DC fast chargers per capita across low-, middle-, and high-income communities, as shown by Figure 7. Generally, low-income census tract communities throughout the state have slightly fewer public chargers per capita than middle- and high-income communities, though about half of all public Level 2 and DCFCs in the state are installed in low-income communities. DC fast chargers do not show a correlation to income level.

**Figure 7: Public Level 2 and DC Fast Chargers Per Capita by Income**

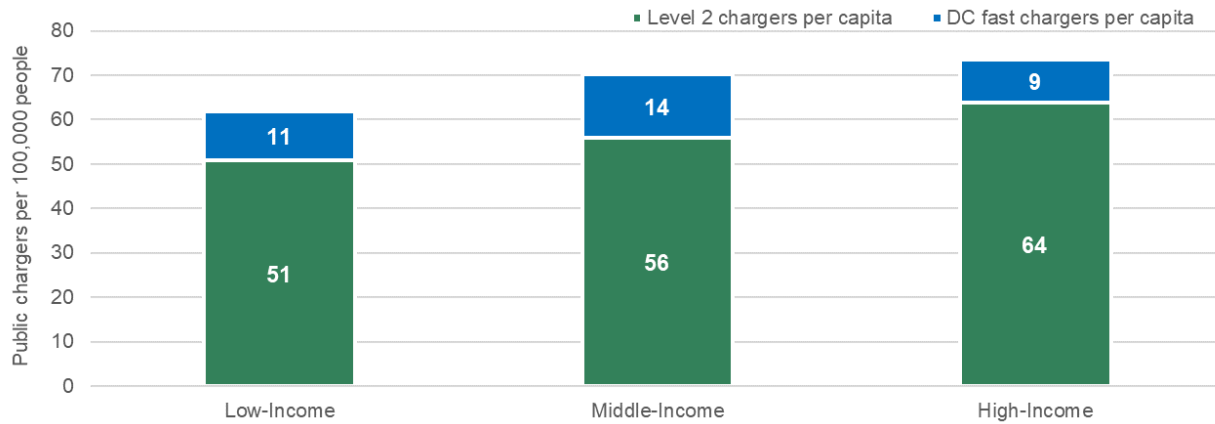

Source: CEC analysis of U.S. Department of Energy Alternative Fuels Data Center (July 23, 2020) and U.S. Census Bureau American Community Survey 2014 – 2018 5-Year Estimates

Taken as a whole, this preliminary analysis provides an overview of existing charger distribution, and indicates that more public charging investments may need to be targeted in low-income communities and high-population-density neighborhoods to enable more proportionate infrastructure distribution throughout the state. However, data gaps and limitations exist. To the best of staffs knowledge, current data, including spatial data, on Level 1, shared private, or private chargers is limited, even though these chargers may account for a significant portion of statewide charging infrastructure (shared private chargers accounted for nearly 40,000 of California’s chargers as of September 30, 2020). Furthermore, a *charger distribution* analysis alone does not present a full picture. For future SB 1000 assessments, staff plan to use new data as it becomes available to evaluate components of *charger access*, which include factors such as housing and occupancy types, the distribution of BEVs and PHEVs, and charger power capacity. Moreover, staff plans to evaluate public charger distribution and access across urban and rural communities, and conduct additional land-use analysis to investigate factors affecting charging access beyond charger location.

## CHAPTER 3:

# Current Transportation Trends

---

### Transportation Greenhouse Gas Emissions Continue to Rise

Transportation is the largest source of GHG emissions in California and directly contributes around 40 percent of the state's GHGs according to 2018 data from the California Air Resources Board (CARB), and more than 50 percent when accounting for oil and gas production and refining (Figure 8).<sup>9</sup> Despite a declining trend in statewide emissions, transportation emissions have seen an increasing trend since 2010 due to factors including rising vehicle ownership,<sup>10</sup> increased vehicle miles traveled, the growth of ride-hailing services, and consumer preferences for larger vehicles. These factors highlight the potential of vehicle electrification to help achieve reductions in emissions.

---

9 California Energy Commission staff. 2019. [2019 Integrated Energy Policy Report](https://www.energy.ca.gov/data-reports/reports/integrated-energy-policy-report/2019-integrated-energy-policy-report). California Energy Commission. Publication Number: CEC-100-2019-001-CMF. Available at <https://www.energy.ca.gov/data-reports/reports/integrated-energy-policy-report/2019-integrated-energy-policy-report>.

10 California Department of Motor Vehicles 2019. "[Estimated Vehicles Registered by County](https://www.dmv.ca.gov/portal/uploads/2020/06/2019-Estimated-Vehicles-Registered-by-County-1.pdf)." Available at <https://www.dmv.ca.gov/portal/uploads/2020/06/2019-Estimated-Vehicles-Registered-by-County-1.pdf>.

**Figure 8: Transportation-Related Emissions Accounted for More Than Half of the State's GHG Emissions in 2018**

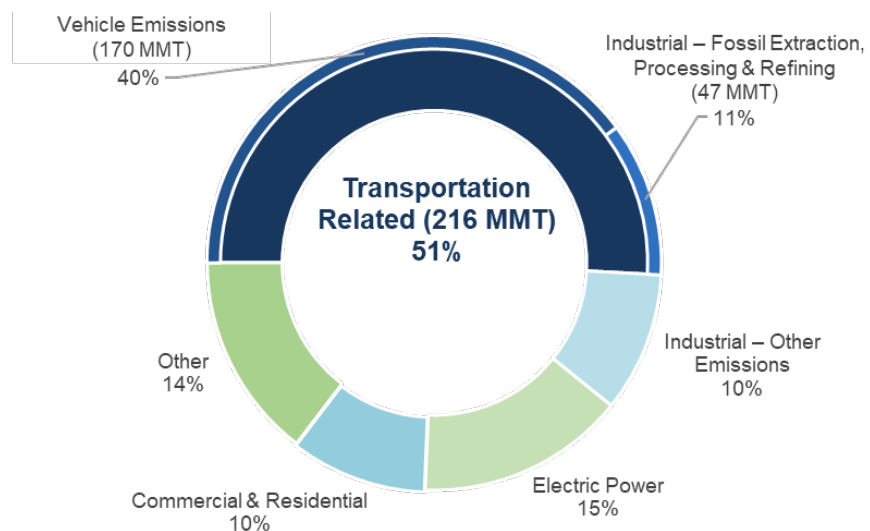

Data Source: CARB 2018 GHG Emission Data Inventory

### **Californians Are Driving More**

Transitioning to ZEVs will be critical to reducing GHG emissions from transportation, especially as Californians have increasingly relied on automobile transport in recent years, but is not the only part of the solution. Figure 9 shows that vehicle miles traveled in California has increased by 50 billion miles, or about 17 percent, from 2012 to 2016.

**Figure 9: California Light-Duty Vehicle Miles Traveled (in Billions)**

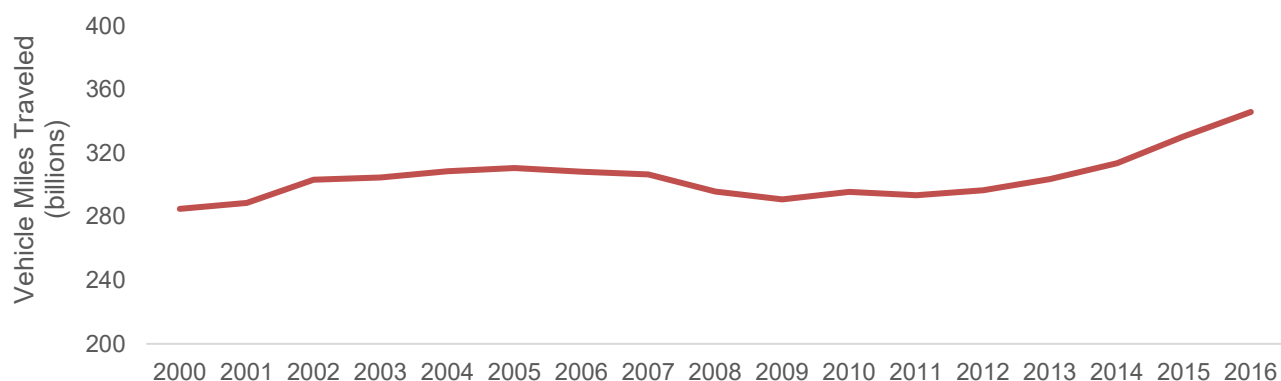

**Light-duty vehicle miles traveled in California roughly constant from 2000 to 2012, then increasing by 50 billion or roughly 17 percent from 2012 to 2016**

Source: CARB Emission Factor Tool 2017

## **Growing Demand and Charging Needs for Ride-Hailing Services**

Rising transportation emissions can be partly attributed to the growing use of ride-hailing transportation network company (TNC) services such as Uber and Lyft. Since the inception of the modern ride-hailing model in 2009, Uber and Lyft have gained more than 50 million users and provided 5.5 billion rides worldwide.<sup>11</sup> CARB estimates that California TNC vehicles accounted for 1.2 percent of all light-duty vehicle miles traveled in 2018, and TNC vehicle emissions per passenger mile traveled were roughly 50 percent higher than the statewide passenger vehicle average, largely due to miles driven with no passengers in the car.<sup>12</sup> The rapid growth of TNCs and associated emissions necessitate targeted regulatory action to help California meet statewide emissions goals.

In 2018, the CPUC and the CARB began implementing the nation's first bill requiring TNCs to reduce emissions. Senate Bill 1014, the Clean Miles Standard, requires TNCs to reduce GHGs on a per-passenger-mile basis. The bill sets annual targets for electric vehicle miles traveled starting with 2 percent in 2023 and increasing to 90 percent by 2030<sup>13</sup> and directs

---

11 Jenn, Alan. 2020. "[Emissions Benefits of Electric Vehicles in Uber and Lyft Ride-Hailing Services.](https://www.nature.com/articles/s41560-020-0632-7)" *Nature Energy*. <https://www.nature.com/articles/s41560-020-0632-7>.

12 CARB staff. 2018. [Senate Bill 1014 Emissions Inventory](https://ww2.arb.ca.gov/sites/default/files/2019-12/SB%201014%20-%20Base%20year%20Emissions%20Inventory_December_2019.pdf). [https://ww2.arb.ca.gov/sites/default/files/2019-12/SB%201014%20-%20Base%20year%20Emissions%20Inventory\\_December\\_2019.pdf](https://ww2.arb.ca.gov/sites/default/files/2019-12/SB%201014%20-%20Base%20year%20Emissions%20Inventory_December_2019.pdf).

13 CARB. 2020. "[Clean Miles Standard Workshop - Proposed Regulation Targets, presentation.](https://ww2.arb.ca.gov/sites/default/files/2020-11/CMS%20Workshop%206_public%20%28002%29.pdf)" [https://ww2.arb.ca.gov/sites/default/files/2020-11/CMS%20Workshop%206\\_public%20%28002%29.pdf](https://ww2.arb.ca.gov/sites/default/files/2020-11/CMS%20Workshop%206_public%20%28002%29.pdf).

TNCs to provide ZEVs for their fleets. Due to the high usage of TNC vehicles, replacing a gasoline TNC vehicle with a ZEV reduces three times more emissions than replacing a personally driven (non-TNC) vehicle. Further, recent data indicate that ZEVs can replace gasoline TNC vehicles while maintaining identical levels of service.<sup>14</sup>

ZEV adoption presents opportunities for TNCs to reduce emissions but raises questions about the effect on public charging infrastructure. In 2018, ZEVs serving in TNC fleets represented fewer than 0.5 percent of the ZEV population in California but used 35 percent of non-Tesla public charging. Furthermore, ZEV TNC drivers on average visit a DC fast charger 2.5 times a day and charge on average 20 kilowatt-hours (kWh) per session,<sup>15</sup> whereas typical ZEV drivers generally do not use DC fast chargers regularly.<sup>16</sup>

Figure 10 illustrates the charging habits of TNC drivers compared to non-TNC drivers in Los Angeles. TNC drivers have a substantially higher propensity to charge between 12 a.m. and 10 a.m. There is also a noticeable dip in charging events for TNC drivers around 8 p.m., whereas this is the busiest charging time for non-TNC drivers. Charging behavior data from San Francisco and San Diego exhibited similar use patterns.<sup>17</sup>

---

14 Jenn, Alan. 2020. "[Emissions Benefits of Electric Vehicles in Uber and Lyft Ride-Hailing Services.](https://www.nature.com/articles/s41560-020-0632-7)" *Nature Energy*. <https://www.nature.com/articles/s41560-020-0632-7>.

15. Ibid

16 Eighty-three percent of California PEV drivers reside in detached houses, and these drivers charge primarily (≥84 percent) at home. Nicholas et al. (2019). [Quantifying the Electric Vehicle Charging Infrastructure Gap Across U.S. Markets](https://theicct.org/sites/default/files/publications/US_charging_Gap_20190124.pdf). The International Council on Clean Transportation. [https://theicct.org/sites/default/files/publications/US\\_charging\\_Gap\\_20190124.pdf](https://theicct.org/sites/default/files/publications/US_charging_Gap_20190124.pdf).

17 Jenn, Alan. 2020. "[Presentation — Optimizing Charging Infrastructure Buildout for TNC Electrification.](https://efiling.energy.ca.gov/getdocument.aspx?tn=234210)" <https://efiling.energy.ca.gov/getdocument.aspx?tn=234210>.



**Figure 10: Daily Charging Profile of TNC and Non-TNC Drivers in Los Angeles**

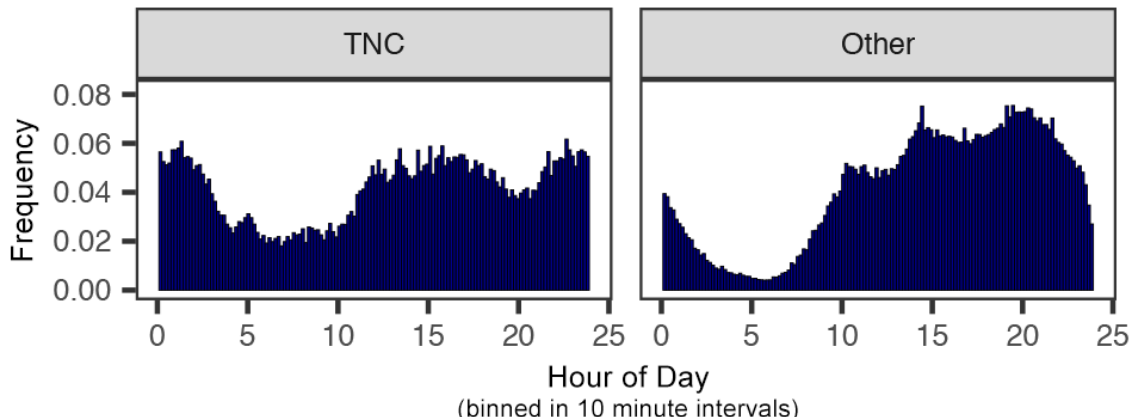

Source: Alan Jenn, UC Davis

### **Light-Duty ZEV Sales Are Growing as Battery Costs Decline**

Light-duty ZEVs continue to gain popularity in California, with growing sales driven in part by vehicle incentives and declining battery prices. Still, the CEC’s 2020 IEPR Update Forecast anticipates only 3.3 million light-duty ZEVs by 2030 in the mid-case and 4.8 million in the aggressive case, both short of California’s goal of 5 million ZEVs by 2030.<sup>18</sup>

Figure 11 compares the CARB Draft Mobile Source Strategy<sup>19</sup> vehicle population scenario, which takes a policy achievement approach and projects the necessary vehicle population to meet state air quality and climate policy goals (including 100% zero-emission new passenger car sales by 2035 per Executive Order N-79-20), with CEC’s IEPR mid case forecast, which is based on transportation demand and reflects market conditions. Despite growing market interest, the CEC’s projections indicate that California must support ZEV adoption more aggressively to achieve its 2030 goal of at least 5 million ZEVs and meet its other policy goals. Charging infrastructure needs are affected by broader trends in the ZEV market, like those described above, and can affect ZEV adoption rates.

---

<sup>18</sup> Bahreinian, Aniss, Mark Palmere. 2020. [Light-Duty Vehicle Forecast 2020 IEPR Update](https://www.energy.ca.gov/media/4717). California Energy Commission. <https://www.energy.ca.gov/media/4717>

<sup>19</sup> CARB staff. 2020. *Draft 2020 Mobile Source Strategy*. <https://ww2.arb.ca.gov/resources/documents/2020-mobile-source-strategy>

**Figure 11: ZEV Adoption Trajectories**

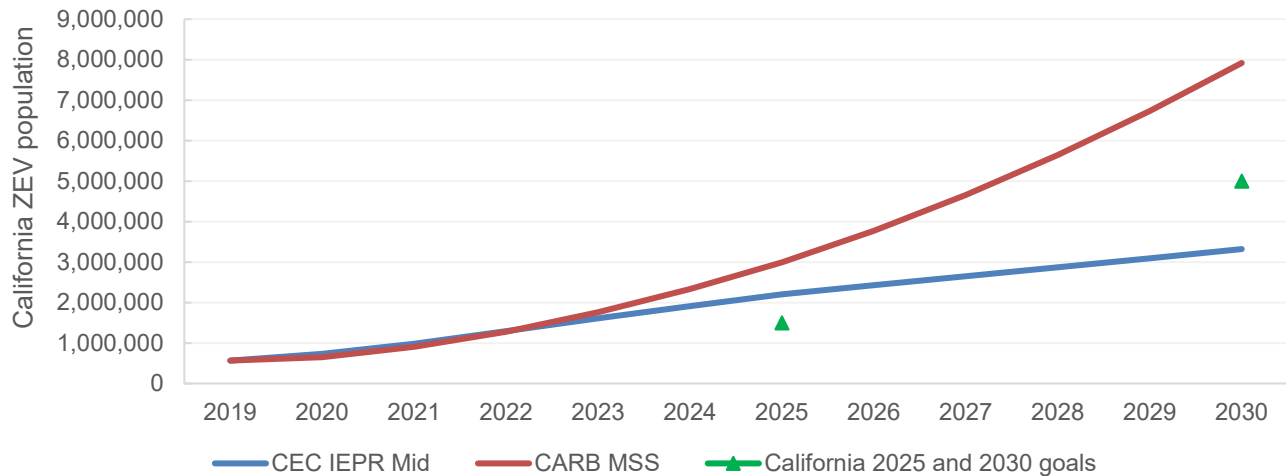

**The CEC’s 2020 Transportation Energy Demand Forecast mid case forecast shows likely ZEV adoption through 2030, with 2.2 million ZEVs in 2025 and 3.3 million in 2030. CARB’s Draft Mobile Source Strategy scenario shows the rate of ZEV adoption needed through 2030 to meet California’s climate and air quality goals. The green triangles show California’s 2025 and 2030 ZEV adoption goals, for reference.**

Source: CEC and CARB staff

At the end of 2019, approximately 567,000 ZEVs were registered in California, including 308,000 battery-electric vehicles, 252,000 plug-in hybrid electric vehicles, and almost 7,000 fuel cell electric vehicles. While ZEVs accounted for nearly 8 percent of California’s new car sales in 2019,<sup>20</sup> adoption was uneven throughout the state. The CEC’s most recent *Energy Equity Indicators* report,<sup>21</sup> which tracks recommendations outlined in the *SB 350 Low-Income Barriers Study*,<sup>22</sup> shows that ZEV adoption varied widely by county and that participation in the state’s Clean Vehicle Rebate Project was especially low in some Central Valley and Inland Empire communities. These findings indicate the potential for more widespread ZEV adoption with additional investment to promote and support ZEVs in these communities.

---

20 California New Car Dealers Association. February 2020. [California Auto Outlook: Volume 16, Number 1](https://www.cncda.org/wp-content/uploads/Cal-Covering-4Q-19.pdf). <https://www.cncda.org/wp-content/uploads/Cal-Covering-4Q-19.pdf>.

21 CEC. 2018. [Energy Equity Indicators Tracking Progress](https://www.energy.ca.gov/sites/default/files/2019-12/energy_equity_indicators_ada.pdf). [https://www.energy.ca.gov/sites/default/files/2019-12/energy\\_equity\\_indicators\\_ada.pdf](https://www.energy.ca.gov/sites/default/files/2019-12/energy_equity_indicators_ada.pdf)

22 CEC. 2016. [Low-Income Barriers Study, Part A](https://efiling.energy.ca.gov/getdocument.aspx?tn=214830&usg=AOvWaw3DzKXFOzCAiOjGLEIAxdYn). <https://efiling.energy.ca.gov/getdocument.aspx?tn=214830&usg=AOvWaw3DzKXFOzCAiOjGLEIAxdYn>

Advancements in vehicle batteries are also driving vehicle price reductions and ZEV adoption. Improved cell designs, higher-energy density cathodes, and economies of scale will contribute to steadily declining battery prices through the 2020s. ZEVs will become more affordable as the cost of batteries continues to decline, and Bloomberg New Energy Finance forecasts that BEVs will achieve purchase cost parity with internal combustion engine vehicles in the U.S. SUV segment as early as 2022–2023 (Figure 12).

**Figure 12: U.S. SUV Segment Price and Share of Battery Cost**

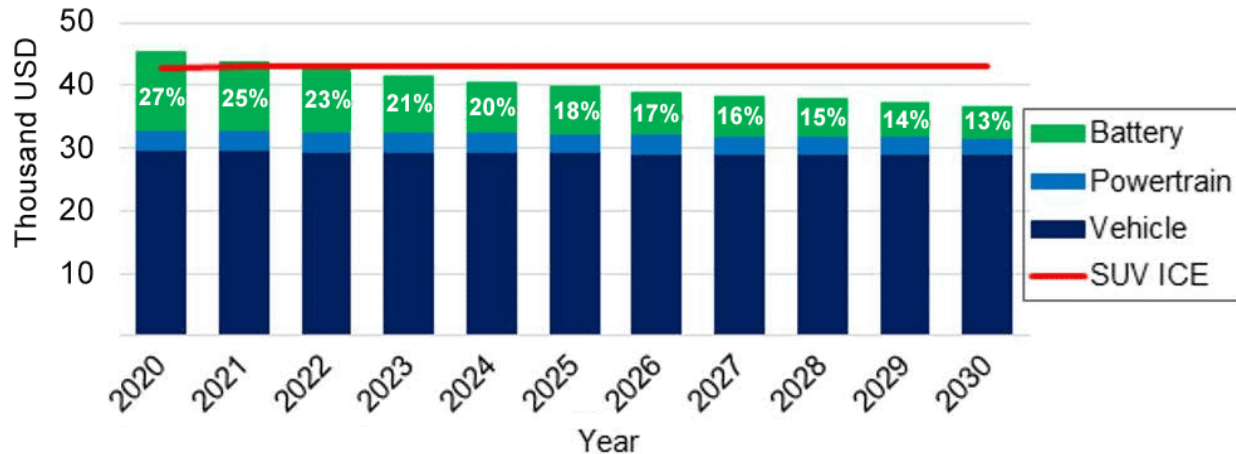

**Forecasted pre-tax vehicle costs for battery-electric vehicles and internal combustion engine vehicles.**

Source: Bloomberg New Energy Finance

The COVID-19 pandemic adds uncertainty. Vehicle sales, including ZEV sales, decreased sharply in California at the onset of the pandemic (Figure 13) and have begun to rebound. ZEV market share of new vehicle sales continued steadily increasing to a high of 7.73% in 2020 as of the third quarter.<sup>23</sup> Furthermore, COVID-19 has spurred several behavioral changes that may affect ZEV adoption. A sustained shift toward remote work may reduce sales of light-duty vehicles, including ZEVs. Conversely, increased demand for groceries and delivered goods may accelerate adoption of electrified commercial vehicles, sales of which Bloomberg New Energy

23 California Energy Commission staff. 2020. "[Light Duty Vehicle Forecast Update.](#)" *Transportation Energy Demand Forecast Update - Commissioner Workshop on Updates to the California Energy Demand 2019-2030 Forecast*. California Energy Commission. <https://efiling.energy.ca.gov/getdocument.aspx?tn=235838>

Finance expects to reach prepandemic levels before other vehicle sectors.<sup>24</sup> It is unclear if these behavior changes will be permanent, and it is difficult to draw long-term conclusions based on recent sales figures given the volatility and seasonality of ZEV sales, as well as the limited data available.

**Figure 13: Quarterly ZEV Sales in California**

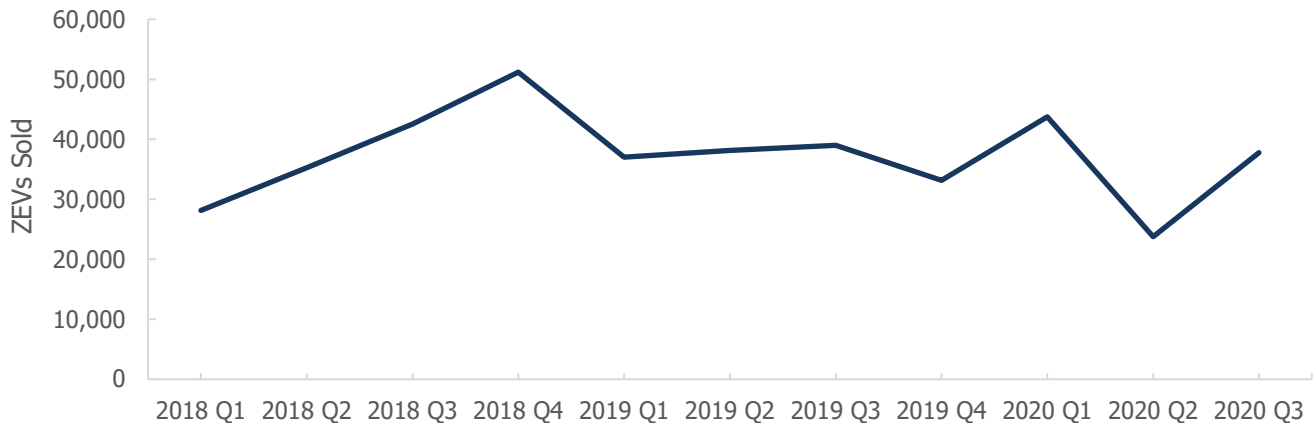

Source: [California Energy Commission via Veloz](#)

## Growing Electrification of the Medium- and Heavy-Duty Sectors

Beyond light-duty passenger cars, CEC staff expects rapid electrification of the state’s medium- and heavy-duty (MD/HD) vehicles and equipment in the next decade. A combination of expanded offerings from manufacturers and new regulations will drive adoption of zero-emissions options across the MD/HD sector, which includes on-road trucks and buses as well as off-road mobile equipment (such as transportation refrigeration units and cargo-handling equipment).

While MD/HD vehicles and equipment are critical to California’s businesses, freight operations, and transit systems, they are responsible for 68 percent of NOx emissions and 91 percent of diesel particulate matter statewide.<sup>25</sup> These pollutants contribute to toxic air and disproportionately harm communities near ports, railyards, distribution centers, and major freight corridors, especially in California’s South Coast region and San Joaquin Valley, which

24 McKerracher, Colin, Ali Izadi-Najafabadi, Aleksandra O’Donovan, Nick Albanese, Dr. Nikolas Soulopolous, David Doherty, Milo Boers, et al. Bloomberg New Energy Finance. 2020. [Electric Vehicle Outlook 2020](https://about.bnef.com/electric-vehicle-outlook/). <https://about.bnef.com/electric-vehicle-outlook/>.

25 CARB. 2019. [Regulatory Drivers for Transportation Electrification of Freight and Off-Road Equipment](https://efiling.energy.ca.gov/GetDocument.aspx?tn=228048&DocumentContentId=59334). <https://efiling.energy.ca.gov/GetDocument.aspx?tn=228048&DocumentContentId=59334>.

suffer among the worst air pollution in the nation.<sup>26</sup> Planning and installing charging infrastructure to support the state’s rapidly electrifying MD/HD sector will be crucial to improving air quality in disadvantaged communities and to achieving the state’s long-term climate goals.

Recent regulations approved by CARB target increasing levels of electrification among on-road MD/HD vehicles. The Advanced Clean Trucks regulation establishes rising manufacturer ZEV sales targets for Class 2b-8 trucks,<sup>27</sup> with implementation beginning with Model Year 2024.<sup>28</sup> Other regulations developed by CARB, such as Innovative Clean Transit,<sup>29</sup> Zero-Emission Airport Shuttle,<sup>30</sup> and Advanced Clean Fleets,<sup>31</sup> target earlier transitions to zero-emissions trucks and buses for select fleets. Executive Order N-79-20 further directs the state to target 100 percent zero-emission operation of the state’s drayage trucks by 2035 and of all medium- and heavy-duty vehicles by 2045, where feasible. A growing portfolio of electrified MD/HD vehicle offerings, including from Daimler, Lion Electric, Proterra, Volvo, and many others, will support this transition.

CEC staff also expects significant growth of zero-emission equipment use in off-road applications. Executive Order N-79-20 directs the state to target 100 percent zero-emission off-road vehicles and equipment by 2035. CARB has proposed new transportation refrigeration unit regulations that will require truck operators to begin transitioning to zero-emission truck

---

26 In particular, the San Joaquin Valley consistently suffers the nation’s worst air quality. The American Lung Association’s 2020 State of the Air report found that the top three cities most polluted by year-round particle pollution were all located in the San Joaquin Valley. American Lung Association. (2020). [State of the Air 2020](https://www.stateoftheair.org/assets/SOTA-2020.pdf). <https://www.stateoftheair.org/assets/SOTA-2020.pdf>

27 Trucks are classified by their gross vehicle weight rating (GVWR). Class 2b includes trucks with a GVWR of 8,501–10,000 pounds. Class 8 includes all trucks with a GVWR of over 33,000 pounds. Advanced Clean Trucks regulates all truck classes between classes 2b and 8.

28 CARB. 2020. "[Advanced Clean Trucks Fact Sheet](https://ww2.arb.ca.gov/resources/fact-sheets/advanced-clean-trucks-fact-sheet)." <https://ww2.arb.ca.gov/resources/fact-sheets/advanced-clean-trucks-fact-sheet>.

29 CARB. 2019. "[Innovative Clean Transit Regulation](https://ww2.arb.ca.gov/sites/default/files/2019-10/ictfro-Clean-Final_0.pdf)." [https://ww2.arb.ca.gov/sites/default/files/2019-10/ictfro-Clean-Final\\_0.pdf](https://ww2.arb.ca.gov/sites/default/files/2019-10/ictfro-Clean-Final_0.pdf)

30 CARB. 2019. "[Zero-Emission Airport Shuttle Regulation](https://ww3.arb.ca.gov/regact/2019/asb/fro.pdf)." <https://ww3.arb.ca.gov/regact/2019/asb/fro.pdf>.

31 CARB. 2020. "[Advanced Clean Fleets](https://ww2.arb.ca.gov/our-work/programs/advanced-clean-fleets/about)." <https://ww2.arb.ca.gov/our-work/programs/advanced-clean-fleets/about>.

transport refrigeration units beginning in 2023.<sup>32</sup> A similar regulation for cargo-handling equipment at seaports and railyards is slated for board consideration in 2022 with implementation beginning in 2026.<sup>33</sup> Separately, the San Pedro Bay Ports have announced an ambitious plan to completely transition to zero-emissions cargo-handling equipment by 2030,<sup>34</sup> and the Port of Oakland has announced plans to accelerate the transition to zero-emissions cargo-handling equipment.<sup>35</sup> Several airports across the state, including San Jose International Airport<sup>36</sup> and Los Angeles International Airport<sup>37</sup> identify electrification of ground support equipment as part of their clean air plans. Increasing commercial availability of electrified construction equipment may also spur modest uptake in the construction industry.

In many cases, MD/HD vehicles and equipment will need to charge as quickly as possible, which will create new multi-megawatt loads. Charging infrastructure planning will be especially important and must address grid constraints, resilience, and compatibility with existing equipment operating schedules, and the lack of a unified charging connector standard for MD/HD vehicles and equipment works against driver convenience and increases the likelihood that chargers installed today are stranded in the future. Electric distribution and transmission system planners are beginning to anticipate large public charging loads,<sup>38</sup> but more detailed analysis is necessary to prepare for the required rollout of charging infrastructure to support this transition.

---

32 CARB. 2020. "[Transportation Refrigeration Unit Rulemaking](https://ww2.arb.ca.gov/our-work/programs/transport-refrigeration-unit)." <https://ww2.arb.ca.gov/our-work/programs/transport-refrigeration-unit>.

33 CARB. 2018. [Concepts to Minimize the Community Health Impacts from Large Freight Facilities](https://ww2.arb.ca.gov/sites/default/files/2020-07/Revised%20Advance%20Materials%20-%2010-2019%20ADA%20Final.pdf). <https://ww2.arb.ca.gov/sites/default/files/2020-07/Revised%20Advance%20Materials%20-%2010-2019%20ADA%20Final.pdf>

34 San Pedro Bay Ports. 2017. [Clean Air Action Plan](https://cleanairactionplan.org/documents/final-2017-clean-air-action-plan-update.pdf/). <https://cleanairactionplan.org/documents/final-2017-clean-air-action-plan-update.pdf/>.

35 Port of Oakland. 2019. [Seaport Air Quality 2020 and Beyond Plan](https://www.portofoakland.com/files/PDF/Volume%20I.pdf). <https://www.portofoakland.com/files/PDF/Volume%20I.pdf>.

36 San Jose International Airport. 2020. [Sustainability Management Plan](https://www.flysanjose.com/sites/default/files/commission/2020_0121_Final%20SMP.PDF). [https://www.flysanjose.com/sites/default/files/commission/2020\\_0121\\_Final%20SMP.PDF](https://www.flysanjose.com/sites/default/files/commission/2020_0121_Final%20SMP.PDF).

37 Los Angeles World Airports. 2019. "[LAX Ground Support Equipment Emissions Reduction Policy](https://www.lawa.org/-/media/lawa-web/environment/files/lax_gse_emission_reduction_policy_boac.ashx)." [https://www.lawa.org/-/media/lawa-web/environment/files/lax\\_gse\\_emission\\_reduction\\_policy\\_boac.ashx](https://www.lawa.org/-/media/lawa-web/environment/files/lax_gse_emission_reduction_policy_boac.ashx).

38 West Coast Clean Transit Corridor Initiative. 2020. [West Coast Clean Transit Corridor Initiative Study](https://www.westcoastcleantransit.com/). <https://www.westcoastcleantransit.com/>.

# CHAPTER 4:

## Modeling California's Charger Needs

---

### Near-Term Gap in Charging Infrastructure

California is on track to surpass its goal of 1.5 million ZEVs on state roadways by 2025 but is behind in providing the charging infrastructure needed to support the growing PEV population. To meet the 2025 goal of 250,000 public and shared chargers, the state needs about 62,000 more than are currently planned, representing a 25 percent shortfall of Level 2 chargers and a 5 percent shortfall of DC fast chargers. Charging infrastructure deployment is lagging vehicle sales, and this gap may stymie progress toward 5 and 8 million ZEVs by 2030.

### Shared and Public Charging Are Key To Enabling Electrification

While most existing PEV drivers charge at single-family homes,<sup>39</sup> shared and public charging infrastructure will be increasingly critical as PEV adoption spreads beyond early adopters. Even with declining vehicle sticker prices, several<sup>40</sup> recent reports<sup>41</sup> emphasized that continued growth in the PEV market will depend on driver confidence in charging infrastructure. Drivers who lack reliable charging at home or work rely on public charging for their mobility needs. Indeed, shared and public charging can allow all Californians access to the benefits of PEVs. A 2020 National Renewable Energy Laboratory study found that public charging provided several

---

39 Eighty-three percent of California PEV drivers reside in detached houses, and these drivers charge primarily (≥84 percent) at home. Nicholas et al. (2019). [Quantifying the Electric Vehicle Charging Infrastructure Gap Across U.S. Markets](https://theicct.org/sites/default/files/publications/US_charging_Gap_20190124.pdf). The International Council on Clean Transportation. [https://theicct.org/sites/default/files/publications/US\\_charging\\_Gap\\_20190124.pdf](https://theicct.org/sites/default/files/publications/US_charging_Gap_20190124.pdf).

40 A survey by Autolist indicated that lack of charging infrastructure was among the top three concerns among prospective buyers. Autolist. August 2019. "[Survey: Price, range and weak charging network are top reasons consumers avoid EVs.](https://www.autolist.com/news-and-analysis/survey-electric-vehicles)" <https://www.autolist.com/news-and-analysis/survey-electric-vehicles>

41 Separately, a study conducted by the Harris Poll on behalf of Volvo found that lack of charging infrastructure was the second largest concern among drivers. Volvo Car USA. February 2019. "[The State of Electric Vehicles in America.](https://www.media.volvocars.com/us/en-us/download/249123)" <https://www.media.volvocars.com/us/en-us/download/249123>

thousand dollars' worth of tangible value to PEV-driving households.<sup>42</sup> The study found that public charging:

- Enables greater interregional BEV travel with public DC fast chargers.
- Provides fuel cost savings to PHEV drivers by enabling drivers to substitute electric miles for what otherwise would have been gasoline miles.
- Substantially decreases the perceived risk of a BEV's "limited range and long recharging time, thereby increasing the likelihood of purchase."
- Increases the public visibility of electric vehicles and creates "confidence in their viability and permanence."

As the state continues building infrastructure to support the state's growing PEV population, policy makers and electric vehicle stakeholders must recognize that meeting the diverse electric mobility needs of Californians cannot be achieved through one-size-fits-all solutions. Thoughtful charger deployment is a significant undertaking that demands careful attention to driver behavior, the local built environment, equity, resiliency, grid capacity, technical standards, and scalability for an assortment of charging solutions. To quantify California's charging needs, the CEC has partnered with the National Renewable Energy Laboratory, Lawrence Berkeley National Laboratory, and the University of California, Davis, to develop quantitative analysis tools covering various vehicle classes, use cases, and local conditions. These analyses are summarized in Table 4 and described in greater detail in the following sections.

---

42 Greene, David L., Matteo Muratori, Eleftheria Kontou, Brennan Borlaug, Marc Melaina, and Aaron Brooker (National Renewable Energy Laboratory). 2020. [Quantifying the Tangible Value of Public Electric Vehicle Charging Infrastructure](https://efiling.energy.ca.gov/getdocument.aspx?tn=233987). California Energy Commission. Publication Number: CEC-600-2020-004. <https://efiling.energy.ca.gov/getdocument.aspx?tn=233987>.



**Table 4: Summary of CEC Charging Infrastructure Quantitative Analyses**

Model	Description
Electric Vehicle Infrastructure Projections (EVI-Pro) 2	Projects charging infrastructure needs to enable electrified short-distance intraregional travel for vehicles weighing 10,000 GVWR or less.
EVI-RoadTrip	Projects charging infrastructure needs to enable all-electric long-distance (>100 mi.) interregional travel.
Widespread Infrastructure for Ride-hailing EV Deployment (WIRED)	Projects charging infrastructure needs to enable electrification of ride-hailing via transportation network companies.
Medium- and Heavy-Duty Electric Vehicle Infrastructure Load, Operation, and Deployment (HEVI-LOAD)	Projects charging infrastructure needs to enable electrification of on-road MD/HD vehicles weighing 10,001 GVWR and above.
EVSE Deployment and Grid Evaluation (EDGE) Model	Geospatially analyzes and tracks local grid capacity, air quality, travel demand, and equity considerations.

Source: CEC

## **EVI-Pro 2**

The Electric Vehicle Infrastructure Projection Tool, EVI-Pro, is a planning tool that helps determine the number, locations, and types of chargers required to meet the needs of California’s light-duty PEV drivers. Using a two-step approach, EVI-Pro estimates the charging demand from light-duty PEVs and designs a supply of residential (including MUDs), workplace, and public charging infrastructure capable of meeting the demand. Developed in 2016 through a collaboration between the CEC and the National Renewable Energy Laboratory, the original EVI-Pro 1 model set the standard for charging infrastructure assessments in California<sup>43</sup> and across the United States.<sup>44</sup>

EVI-Pro 1 estimated that 120,000 public and shared Level 2 chargers, 10,000 public and shared DC fast chargers, and 120,000 chargers at MUDs are needed to support 1.5 million

---

43 Bedir, Abdulkadir, Noel Crisostomo, Jennifer Allen, Eric Wood, and Clément Rames. 2018. *California Plug-In Electric Vehicle Infrastructure Projections: 2017-2025*. California Energy Commission. Publication Number: CEC-600-2018-001.

44 Electric Vehicle Infrastructure Projection Tool (EVI-Pro) Lite. U.S. Department of Energy Alternative Fuels Data Center, November 30, 2020. <https://afdc.energy.gov/evi-pro-lite>

ZEVs in 2025. These formed the basis for the Executive Order B-48-18 target of 250,000 electric vehicle chargers statewide by 2025, including 10,000 DC fast chargers.<sup>45</sup>

An update to the model, EVI-Pro 2, expands infrastructure projections to support 5 million ZEVs and beyond by 2030 and incorporates evolving technology and market conditions. The baseline scenario of 5 million ZEVs uses the CEC’s aggressive forecast from the 2020 IEPR Transportation Energy Demand Forecast update. This forecast projects approximately 4.7 million ZEVs by 2030, but for this analysis the forecast has been scaled up to 5 million ZEVs. In addition, two other scenarios are being used to reflect lower and upper bounds for ZEV projections. The lower bound utilizes the CEC’s low forecast from the 2020 IEPR, which projects about 2 million ZEVs by 2030. The upper bound uses CARB’s Draft Mobile Source Strategy scenario<sup>46</sup>, which includes approximately 8 million ZEVs by 2030, the trajectory needed to achieve the Executive Order N-79-20 target of 100% light-duty ZEV sales by 2035.

Table 5 outlines critical differences between EVI-Pro 1 and the three scenarios in EVI-Pro 2. In addition, Appendix B details the key parameters and inputs used in EVI-Pro 2.

**Table 5: Comparison of Primary Input Parameters for EVI-Pro 1 and 2**

	<b>EVI-Pro 1</b>	<b>EVI-Pro 2 (low scenario)</b>	<b>EVI-Pro 2 (baseline)</b>	<b>EVI-Pro 2 (high scenario)</b>
<b>ZEV Population</b>	1.5 million in 2025	1.9 million in 2030	5.0 million in 2030	7.9 million in 2030
<b>PEV / Hydrogen Fuel Cell Electric Vehicle Split</b>	87/13% in 2025	95/5% in 2030	96/4% in 2030	95/5% in 2030
<b>Within PEVs, PHEV / BEV Split</b>	45/55% in 2025	38/62% in 2030	30/70% in 2030	30/70% in 2030
<b>Charging Behavior Objective</b>	Maximize electric vehicle miles traveled	Mirror observed behavior	Mirror observed behavior	Mirror observed behavior
<b>PEVs w/ Home Charging</b>	92%	81%	72%	67%
<b>Time-of-Use Rate Participation</b>	Not included	67% in 2030	67% in 2030	67% in 2030
<b>Infrastructure Utilization</b>	Assumed	Observed	Observed	Observed

Source: CEC and National Renewable Energy Laboratory

<sup>45</sup> California Energy Commission staff. 2018. "California Plug-In Electric Vehicle Infrastructure Projections: 2017-2025." California Energy Commission. Publication Number: CEC-600-2018-001.

<sup>46</sup> CARB staff. 2020. *Draft 2020 Mobile Source Strategy*. <https://ww2.arb.ca.gov/resources/documents/2020-mobile-source-strategy>

## Modeling Results

Table 6 shows preliminary results from EVI-Pro 2. To support 5 million ZEVs in 2030, the state will need 710,000 to 752,000 Level 2 plugs at public destinations (for example, shopping centers) and workplaces, and 30,500 to 32,100 public DC fast charger plugs. These DC fast chargers are modeled to support travel within a region; EVI-RoadTrip (discussed in the next section) models the need for additional DC fast chargers to support travel between regions. While in practice, some DC fast chargers will be used for both intraregional and interregional purposes, the estimates tabulated below do not reflect this synergy and therefore may slightly overestimate the number of needed DC fast chargers. An additional 181,000 to 223,000 Level 1 and Level 2 plugs are required to support MUDs. In total, EVI-Pro 2 projects that California will need between 921,500 to 1,007,100 chargers to support 5 million ZEVs in 2030, with an average projection of nearly 965,000 chargers.

EVI-Pro 2 can also inform the charging infrastructure needs for scenarios with higher ZEV populations. For instance, in the primary scenario of CARB's Draft 2020 Mobile Source Strategy document, reaching the new Executive Order target of 100% zero-emission new passenger car sales by 2035 might require up to 8 million ZEVs and PHEVs in the fleet by 2030.<sup>47</sup> Such a scenario could result in a roughly 50 percent increase in charging infrastructure needs. In this scenario, 1,156,000 to 1,223,000 public and workplace Level 2 plugs are needed, along with 53,100 to 55,900 public DC fast charger plugs. In addition, 258,000 to 316,000 Level 1 and Level 2 plugs are needed to support MUDs. This yields a total of 1,467,100 to 1,594,900 plugs to support 8 million ZEVs in 2030, with an average of 1,531,000 plugs.

---

47 CARB. Draft Mobile Source Strategy 2020. November 24, 2020.  
[https://ww2.arb.ca.gov/sites/default/files/2020-11/Draft\\_2020\\_Mobile\\_Source\\_Strategy.pdf](https://ww2.arb.ca.gov/sites/default/files/2020-11/Draft_2020_Mobile_Source_Strategy.pdf)

**Table 6: Projected Chargers Needed to Support Intra-Regional Travel in 2030**

Plug Type	Low Scenario 1.9 Million ZEVs (1000 plugs)			Baseline Scenario 5 Million ZEVs (1000 plugs)			High Scenario 7.9 Million ZEVs (1000 plugs)		
	Low	Average	High	Low	Average	High	Low	Average	High
MUDs (Level 1+2)	87	96.5	106	181	202	223	258	287	316
Work (Level 2)	121	125	129	335	345	355	556	572	588
Public (Level 2)	142	146.5	151	375	386	397	600	617.5	635
All Level 1 and 2	350	368	386	891	933	975	1,414	1,476.5	1,539
Public (DC fast chargers)	9.5	9.8	10.1	30.5	31.3	32.1	53.1	54.5	55.9
Total Chargers	359.5	377.8	396.1	921.5	964.3	1,007.1	1,467.1	1,531	1,594.9

Source: CEC and National Renewable Energy Laboratory

As shown in Figure 14, EVI-Pro 2 also suggests that charging power demand in 2030 will result in an additional load of 3.6 GW at midnight, adding up to 15 and 16 percent to total electric load during that time period on weekdays and weekends, respectively.<sup>48</sup> The load profile is distinct in shape from that of EVI-Pro 1, with a noticeable shift from an early evening ramp in load in EVI-Pro 1 to a midnight spike in load in EVI-Pro 2. This is due to the incorporation of time-of-use (TOU) rate participation in EVI-Pro 2. TOU participation is based on an accelerated uptake of residential TOU rate adoption assumed within CEC’s California Electricity Demand analyses.<sup>49</sup> EVI-Pro 2 assumes that all vehicles that have access to home charging are on a TOU rate set a timer to begin charging at midnight to avoid loading the transmission system when commuters arrive home during the evening peak. Future work will investigate the potential benefits of staggering charging times to moderate load impacts, as the current step-wise increase of over 2.5 GW at midnight will present challenges to distribution equipment. For example, the coincidence of charging clustered in neighborhoods may cause voltage issues or overload secondary transformers.

---

48 Cumulative load from LD EV charging peaks at 3.6 GW at midnight. This is projected to be up to 15 percent of projected load on April 2, 2030 (likely the lowest weekday midnight load that year) and 16 percent of projected load on March 31, 2030 (likely the lowest weekend midnight load that year).

49 CEC staff-developed participation rates for the Transportation Energy Demand Forecast for the 2020 IEPR Update, Transportation Energy Demand Forecast Update - Commissioner Workshop on Updates to the California Energy Demand 2019-2030 Forecast, December 3, 2020. <https://www.energy.ca.gov/event/workshop/2020-12/session-1-transportation-energy-demand-forecast-update-commissioner-workshop>

Furthermore, a decrease in the assumed proportion of home charging access<sup>50</sup> led to an increase in DC fast charging demand. This results in DC fast charging contributing a larger share of the load profile than prior analysis. The high power demand of DC fast chargers and the stochastic nature of when charging events occur may lead to highly-loaded demand profiles in distribution grids (pictured as a spiky load profile). It is important to note that this load profiling is somewhat exaggerated by the model due in part to limitations in travel schedule inputs. In reality, aggregate DC fast charging load will be smoother and less variable, though these will manifest as acute loads at individual sites.

The load profiles for the low (around 2 million ZEVs) and high (around 8 million ZEVs) scenarios are similar in shape to the baseline, although the magnitudes of charging load differ due to the different fleet sizes. In addition, the share of residential and public charging differs due to the assumption around home charging access, which is a variable dependent on the PEV fleet size. As PEV adoption expands to include more drivers without a place to charge at home, the proportion of drivers with home charging access decreases. This means that the load profile for the 8 million ZEV scenario results in a larger share of public charging than the 5 million ZEV scenario.

---

50 National Renewable Energy Laboratory and California Energy Commission. July 2020. Residential parking facility survey among California residents [online].

**Figure 14: Projected 2030 Weekday Statewide PEV Charging Load**

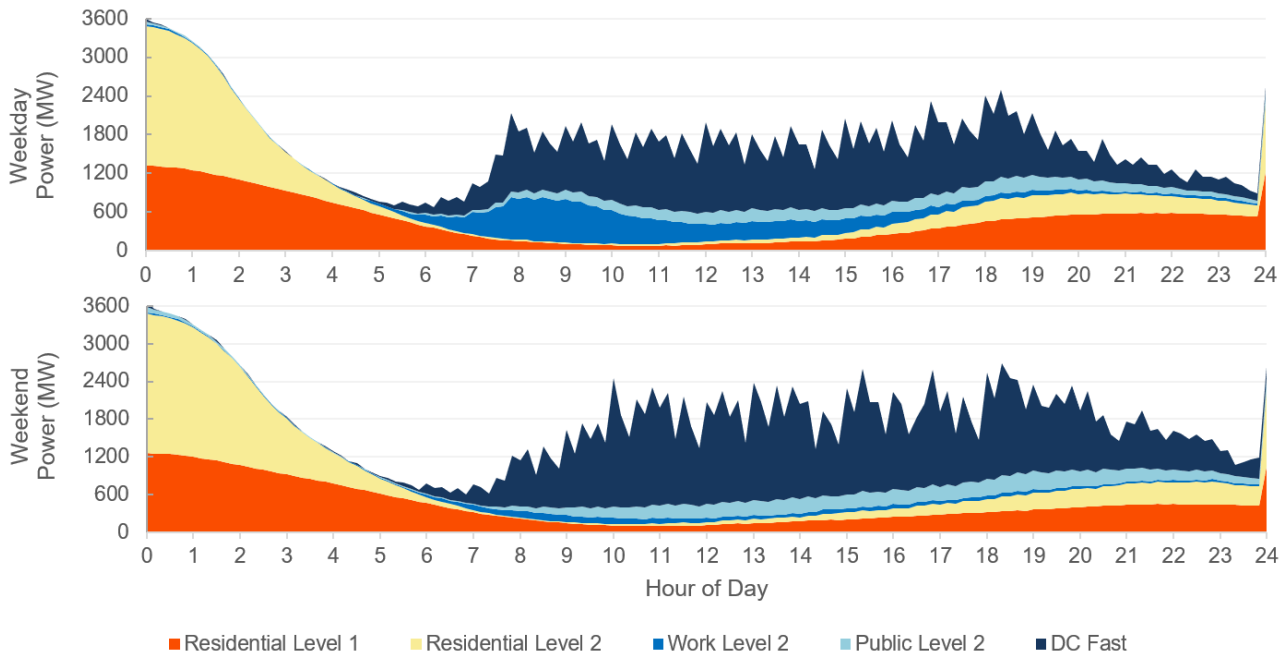

**The projected statewide load profiles indicate a peak load of nearly 3.6 GW around 12 a.m. and just under 2.5 GW between 6 and 7 p.m., respectively. These results suggest that although typical charging load from DC fast chargers aligns with daytime solar generation, nighttime charging may overload distribution equipment and affect power quality around midnight when timed charging takes effect due to simultaneous responses to off-peak time-of-use rates.**

Source: EVI-Pro 2

## **Policy Implications**

Preliminary results from EVI-Pro 2 suggest that California will need between 921,500 to 1,007,100 chargers to support the intra-regional travel demands of 5 million ZEVs in 2030, with an average projection of nearly 965,000 chargers. When accounting for planned future installations, current estimates indicate that there will be 188,000 chargers statewide in 2025, meaning that California will need more than 750,000 additional chargers to meet charging demand modeled by EVI-Pro 2 in 2030. These results also highlight the importance of TOU rates, shifting the EV residential charging load from an early evening ramp coinciding with the total electricity system peak, to a sharp instantaneous EV load peak at midnight. The load implications of TOU participation and automating the management of charging should be considered as TOU rate structures evolve and become more widely adopted. While TOU rates can shift load to more beneficial times, additional smart charging protocols beyond TOU rates will be needed to optimally manage EV charging load and protect distribution grid infrastructure. The significant amount of power demanded by PEVs in these scenarios highlights a critical need for incentives, rate structures, advanced technologies, and other means working in conjunction to enable and encourage smart charging and vehicle-grid integration.

While this analysis was conducted at the statewide level, forthcoming results will consider a geospatial resolution at least at the county level and inform an assortment of planning needs, CEC and industry investments, and programs to address charging use cases including MUDs and low-income communities. At the distribution system level, these results will be critical for planning entities to prepare for growing PEV adoption and charging demand and successfully install infrastructure using the most effective charging solution for the built environment and use case. At the statewide bulk power level, these results will be coordinated with analyses of possible transmission system congestion.<sup>51</sup>

Future work will also continue to investigate scenarios with greater charging load management.<sup>52</sup> In addition, staff will work with partner agencies to continue updating EVI-Pro 2 as newer vehicle population scenarios become available.

A report discussing EVI-Pro 2 findings is expected by the end of the first quarter of 2021. In addition to the county level resolution described above, it will include further detail on the inputs used in the model, the model's methodology, and additional forecast scenarios out to 2035.

EVI-Pro 2 results for "alternative future" scenarios can be found in Appendix C. These four scenarios make slight modifications to the assumptions or customer preferences in the EVI-Pro 2 scenario described above to explore potential futures given the uncertainty of how the electric transportation landscape may evolve in the next decade. Further description of the scenarios and results are found in Appendix C.

A few key takeaways emerge from these alternative future scenarios. In a first scenario, removing TOU participation and timed midnight residential charging exacerbates both the ramping load and total system electricity peak load in the early evening. This highlights the grid benefits that investor owned utilities (IOUs), publicly owned utilities (POUs), and community choice energy providers can realize by providing customers TOU rate options and managing charging equipment. In a second scenario, decreasing home charging access leads to a significant increase in daytime DC fast charging demand, as drivers replace long-duration overnight charging with fast public charging to meet their energy and travel needs. While access to home charging should still be a priority and remains one of the key benefits and incentives of owning an EV, the potential for a properly sized and distributed DC fast charging

---

51 Kintner-Meyer, M., S. Davis, S. Sridhar, D. Bhatnagar, S. Mahserejian, and M. Ghosal (Pacific Northwest National Laboratory). 2020. *Electric Vehicles at Scale – Phase I Analysis: High EV Adoption Impacts on the Western U.S. Power Grid*. [https://www.pnnl.gov/sites/default/files/media/file/EV-AT-SCALE\\_1\\_IMPACTS\\_final.pdf](https://www.pnnl.gov/sites/default/files/media/file/EV-AT-SCALE_1_IMPACTS_final.pdf).

52 Wood, Eric, Dong-Yeon (D-Y) Lee, Nicholas Reinicke, Yanbo Ge, and Erin Burnell (National Renewable Energy Laboratory). 2020. "Presentation — Electric Vehicle Infrastructure Projection Tool (EVI-Pro)." Integrated Energy Policy Report August 6, 2020, Workshop. <https://efiling.energy.ca.gov/getdocument.aspx?tn=234215>.

network to act as an alternative for home charging offers an opportunity for further EV penetration and increased alignment with solar generation. Finally, in a third scenario including Level 1 charging as an additional option for public and workplace charging has the technical potential to accommodate low-energy charge sessions and reduce the number of Level 2 plugs needed, but this does not come as a one-to-one replacement. The resulting Level 1 and Level 2 network requires 250 thousand more plugs than the Level 2-only network described in this chapter. This 35 percent increase in the network size would imply additional equipment and site acquisition costs, as more chargers are required to serve the same amount of electricity.

## **EVI-RoadTrip**

The EVI-RoadTrip model projects the number and locations of DC fast chargers needed to enable electrified road trips within and across California's borders. EVI-RoadTrip differs from EVI-Pro 2 in the scope of the analysis: EVI-RoadTrip focuses on long-distance interregional (100+ mile) trips, while EVI-Pro 2 focuses on short-distance intraregional trips for daily routines. Further, EVI-RoadTrip analyzes BEVs and DC fast chargers only, while EVI-Pro 2 also considers Level 1 and Level 2 chargers to support both BEVs and PHEVs.

EVI-RoadTrip follows four key steps: trip data generation, energy and charging simulation, station siting and sizing, and grid hosting capacity analysis. The model simulates electrified road trips across California (interregional and out-of-state), estimates energy use and charging demands along the road trip routes, calculates clusters of charging demands, and locates charging stations to serve those clusters in preferred areas (such as retail and shopping areas) with the appropriate chargers.

## **Modeling Results**

Table 7 shows the number of needed DC fast chargers and stations in 2030 for low, baseline, and high BEV adoption scenarios. In the baseline scenario, California will need between 1,849 and 6,496 DC fast chargers (average 4,173) located at 907 to 1,181 stations (average 1,044) to support electric interregional travel. These numbers assume drivers will unplug their vehicle when the battery reaches around 80% state of charge, as charge power diminishes significantly at higher states of charge.

The baseline scenario assumes a BEV adoption rate of roughly 10 percent in 2030 (that is, BEVs account for 10 percent of all passenger cars), or around 3 million BEVs. This number is smaller than the aforementioned goal of 5 million ZEVs by 2030, as the model assumes the remaining ZEVs (PHEVs and FCEVs) do not use DC fast charging for interregional travel.



**Table 7: DC Fast Chargers Needed to Support 2030 Interregional Electric Travel**

	<b>Low</b>	<b>Baseline</b>	<b>High</b>
<b>2030 BEV Adoption Rate</b>	5%	10%	17%
<b>Fast Charge Stations</b>	788-932	907-1,181	1,039-1,338
<b>Fast Charge Plugs</b>	1,364-4,580	1,849-6,496	2,108-7,408

Source: CEC and National Renewable Energy Laboratory

In practice, some DC fast chargers will be used for both intraregional and interregional purposes. The estimates shown above do not reflect this synergy and therefore may slightly overestimate the number of needed DC fast chargers.

EVI-RoadTrip also models the locations of needed fast charging infrastructure based on existing land use data and simulated clusters of charging demand (Figure 15). Modeling results indicate that the majority of these stations would be located at retail and shopping areas (55 percent), with most of the remaining stations at recreation and park areas (28 percent), gas stations (14 percent), and airports (2 percent). EVI-RoadTrip locates some stations out of state to accommodate trips with routes that include out-of-state segments.

**Figure 15: Station Locations to Support 2030 Interregional Electric Travel**

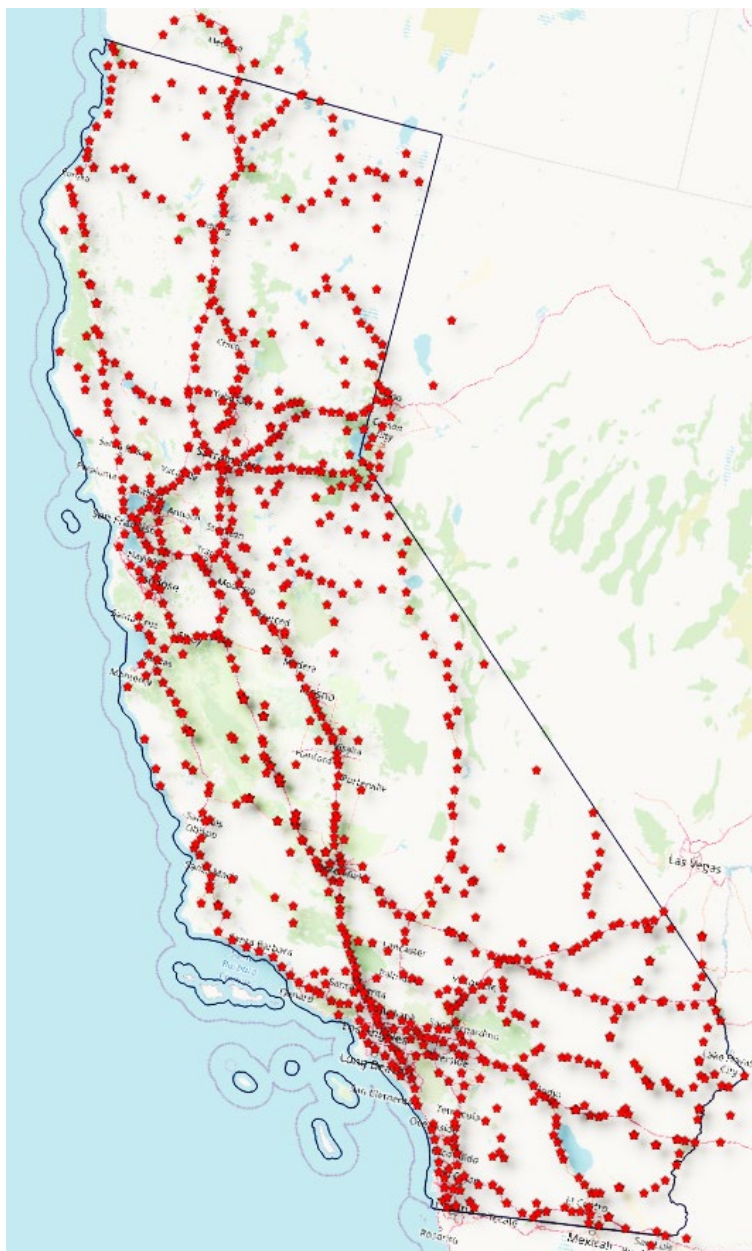

**EVI-RoadTrip models the locations of needed fast charging infrastructure based on existing land use data and simulated driver charging demand.**

Source: CEC and National Renewable Energy Laboratory

The typical weekday load profile projected by EVI-RoadTrip (Figure 16) indicates that power demand from interregional DC fast charging will peak at nearly 40 MW between 2 and 4 p.m. in 2030. The load profile shown assumes that drivers will unplug once the battery nears 80% state of charge, and different charging behaviors will alter systemwide demand. For example, EVI-RoadTrip estimates that if all drivers always charge to 99 percent state of charge, peak

power demand from interregional DC fast charging will more than double to nearly 90 MW around 4 p.m. An analysis of Southern California Edison’s territory using the CEC’s EDGE (discussed later in this chapter) tool shows that current grid capacity should be able to accommodate charging demand from these road trips.

**Figure 16: Projected 2030 Load Curve for Interregional DC Fast Charging**

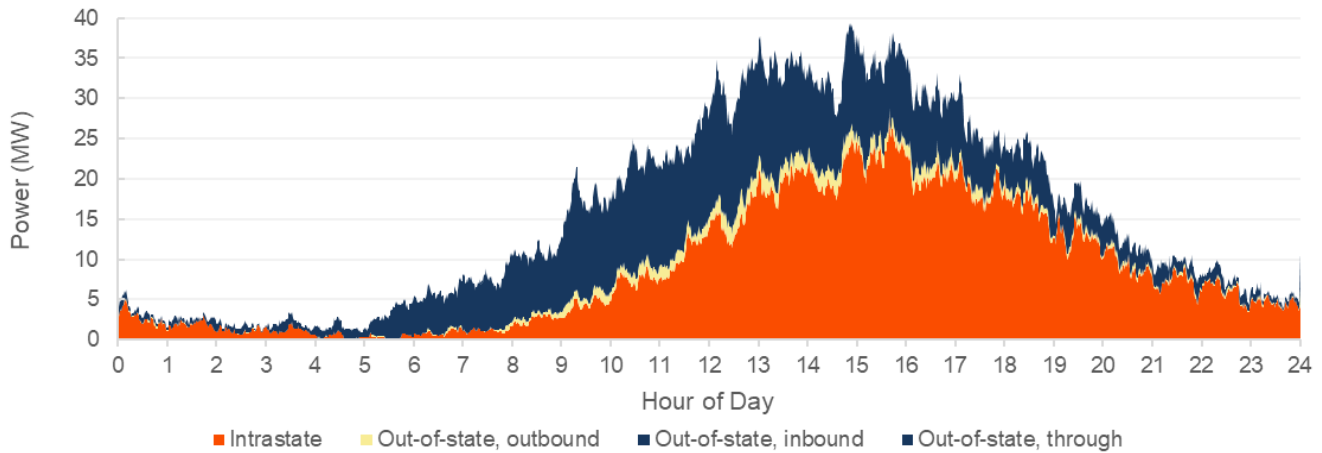

**EVI-RoadTrip projects that DC fast charging to support interregional BEV travel will peak in the midafternoon around 2-4 p.m.**

Source CEC and National Renewable Energy Laboratory

Staff will work with partner agencies to continue updating EVI-RoadTrip as newer vehicle population scenarios become available. A report discussing EVI-RoadTrip findings is expected by the end of the first quarter of 2021. The report will map specific locations of charger need, and will include further detail on the inputs used in the model, its methodology, and additional forecast scenarios out to 2035.

### Policy Implications

Several policy implications emerge from EVI-RoadTrip. Importantly, the results indicate that road trip charging demand may be accommodated by the current grid infrastructure. However, as discussed elsewhere in this report, the charging load associated with other types of trips and vehicles may require significant grid upgrades or impact mitigation using distributed energy resources, smart charging (discussed in greater detail in Chapter 5), or other measures.

Even with a growing BEV population, EVI-RoadTrip finds that technology improvements such as longer-range vehicles and higher charging power will moderate the growth in the number of stations and plugs required in 2030, indicating the importance of future-proofing equipment and encouraging charging connector interoperability today. Further, the model identifies several station sites in neighboring states to accommodate routes which include portions of out-of-state travel, highlighting the need for inter-state collaboration.

Finally, this analysis, which is based on assumptions surrounding travel demand, driver behavior, and charging session characteristics, highlights the need for high-quality data on travel behavior and charging session-level profiles to improve model accuracy.

## **WIRED**

The Widespread Infrastructure for Ride-Hailing EV Deployment (WIRED) model, developed by UC Davis, assesses the need for charging infrastructure demanded by TNC vehicles, initially in three major California regions: San Diego county, the Greater Los Angeles region, and the San Francisco Bay Area. Understanding the charging infrastructure needs of TNC vehicles is especially important in light of CARB's Draft Clean Miles Standard, ordered by SB 1014, which calls for TNCs to electrify 50% of vehicle miles traveled by 2027 and 90% by 2030.<sup>53</sup> In addition, the emissions benefits of electrifying a vehicle in a TNC fleet are nearly three times greater than the benefits for electrifying a privately-owned vehicle – due largely to greater average miles traveled and passenger occupancy of a TNC vehicle.<sup>54</sup>

WIRED uses empirical data from Lyft and Uber trips and aims to minimize charger equipment cost, network installation size, driver use cost, as well as travel and charging time. The model outputs the number of chargers needed at the aggregated census tract level across the three major metropolitan regions mentioned above. This analysis assumes that 80% of the 333,000 ZEVs projected to be in TNC fleets in California by 2030<sup>55</sup> are operating in the regions. These vehicles were then modeled as BEVs or PHEVs based on the yearly projection used in EVI-Pro 2. TNC PEVs were assumed to rely completely on public charging, with no use of overnight charging.

## **Modeling Results**

WIRED projects a steady increase in the number of chargers required in each city, with DC fast chargers accounting for most of the need, especially in the Los Angeles and San Diego regions. Figure 17 shows this increase over time, disaggregated by charger type. Figure 18 shows the different needs for charging infrastructure in the regions studied, based on differences in energy demanded to power their fleets. By 2030, a total of about 2,000 Level 1 and Level 2 chargers will be needed, along with nearly 7,000 DC fast chargers across the three regions.

---

53 CARB Staff. 2020. *Draft Regulation Order - Clean Miles Standard*. <https://ww2.arb.ca.gov/sites/default/files/2020-11/CMS%20Draft%20Regulation%20Order.pdf>

54 Jenn, Alan. 2019. *National Center for Sustainable Transportation*. "Emissions Benefits of Electric Vehicles in Uber and Lyft Services." UC Davis Institute of Transportation Studies. <https://escholarship.org/uc/item/15s1h1kn>

55 CARB Staff. November 19, 2020. *Clean Miles Standard Workshop*. "Proposed Regulation Targets." [https://ww2.arb.ca.gov/sites/default/files/2020-11/CMS%20Workshop%206\\_public%20%28002%29.pdf](https://ww2.arb.ca.gov/sites/default/files/2020-11/CMS%20Workshop%206_public%20%28002%29.pdf)

**Figure 17: Chargers Needed to Support TNC PEVs (2023-2030)**

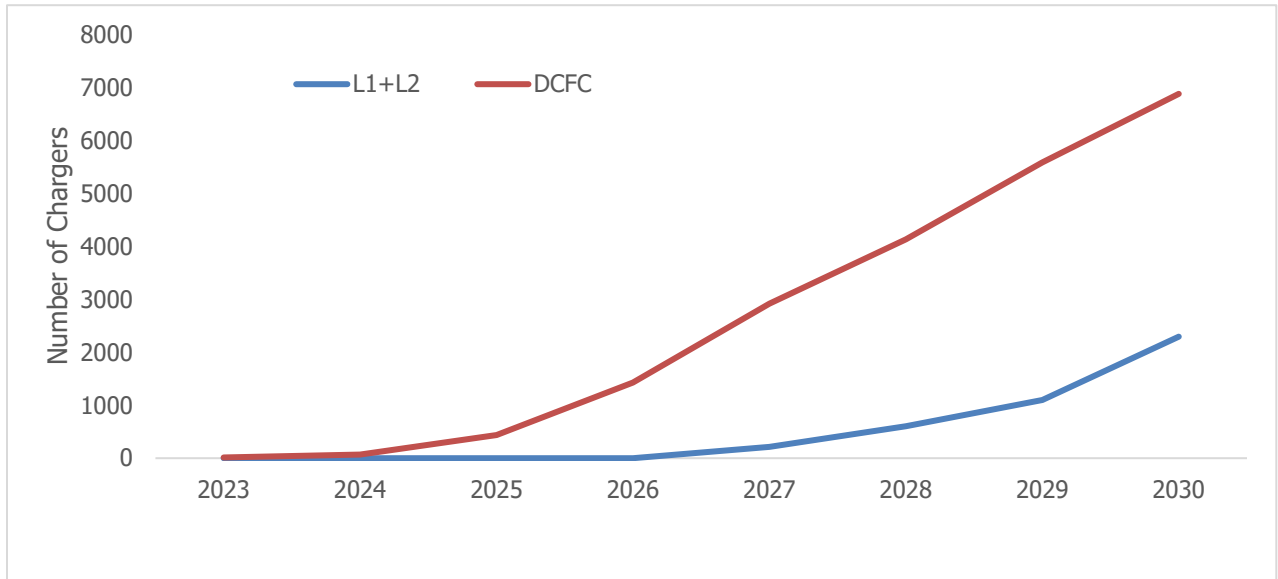

**Aggregated charging infrastructure needs modeled by WIRED in the Greater Los Angeles region, San Diego county, and the San Francisco Bay Area.**

Source: UC Davis

**Figure 18: Chargers Needed to Support TNC PEVs in 2030 by Region**

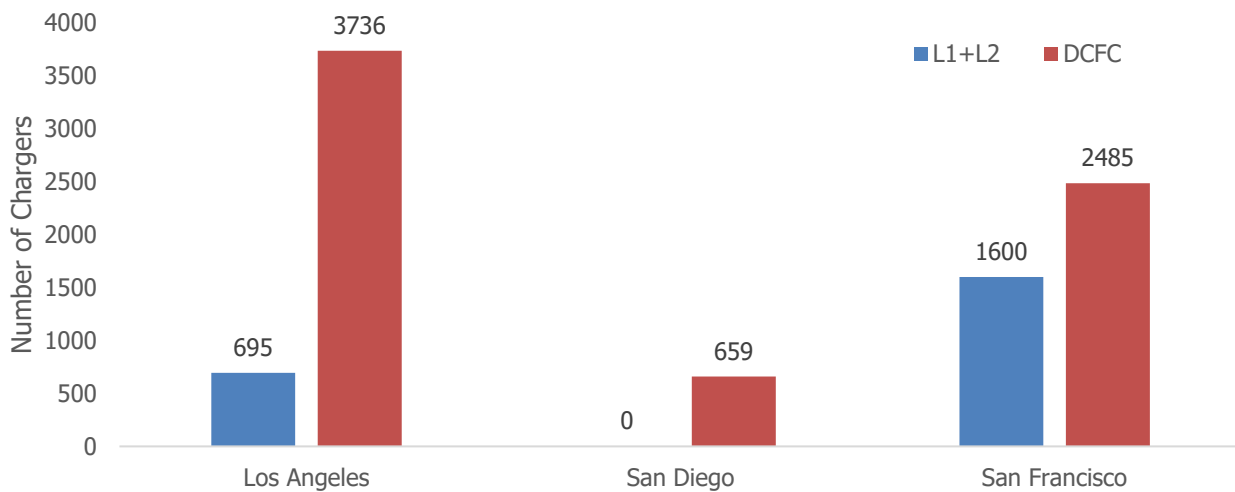

**WIRED models transportation network company infrastructure requirements, illustrating how different regional trip demands vary the resulting network design.**

Source: UC Davis

## Future Refinements and Policy Implications

Future iterations of WIRED will integrate existing stations and projections of public infrastructure not related to TNC charging (such as those from EVI-Pro 2 and EVI-RoadTrip) to determine the potential for multiple travel use cases to be served by individual chargers, improving the effectiveness of the network. The analysis may also extend beyond the three regions currently considered.

The results indicate that TNC PEVs demand more chargers, especially DC fast chargers, than privately-owned PEVs.<sup>56</sup> Additionally, TNC charging demand is most significant near airports and downtown areas. Further, the demand is highly dependent on model inputs regarding preferences to minimize travel time versus willingness to spend time charging. For example, if travel time is given less importance, more Level 1 and Level 2 chargers would be demanded. Finally, if overnight charging owned by PEV drivers can be used, additional charging demand drops significantly. Policymakers should consider these factors when crafting TNC fleet electrification policies.

## **HEVI-LOAD**

The Medium- and Heavy-Duty Electric Vehicle Infrastructure Load, Operations, and Deployment (HEVI-LOAD) model aims to characterize regional charging infrastructure needs in 2030 for public, shared private, and private charging for on-road medium- and heavy-duty electric vehicles. It will determine the number, locations, and types of charger deployments and examine suitable power levels ranging from overnight charging (<50 kW) to public fast charging (multi-megawatt) for the range of applications envisioned in California's transition to ZEVs. HEVI-LOAD began development in 2020 under a collaboration between Lawrence Berkeley National Laboratory and the CEC.

The current approach for HEVI-LOAD uses three-steps: vehicle projection, trip disaggregation, and infrastructure assessment.<sup>57</sup> Medium- and heavy-duty vehicle energy consumption is derived from a vehicle powertrain physics model that is informed by a CARB truck

---

56 Jenn, Alan. 2020. *Transportation Research Board* (accepted conference paper). "Charging Forward: Deploying EV Infrastructure for Uber and Lyft in California."

57 Wang, Bin, Doug Black, Fan Tong, and Cong Zhang (Lawrence Berkeley National Laboratory). 2020. "[Presentation — Medium- and Heavy-Duty Electric Vehicle Infrastructure Projections \(HEVI-Pro\)](https://efiling.energy.ca.gov/getdocument.aspx?tn=234209)." Integrated Energy Policy Report August 6th workshop. <https://efiling.energy.ca.gov/getdocument.aspx?tn=234209>.

electrification viability analysis<sup>58</sup> and the emission factor (EMFAC) tool.<sup>59</sup> Future electric vehicle penetrations are derived from a truck choice model used for the Transportation Energy Demand Forecast (TEDF) as lower bounds.<sup>60</sup> The scenario of the Mobile Source Strategy, which support near-term air quality improvement and long-term decarbonization, serve as an upper bound.<sup>61</sup>

HEVI-LOAD considers more than 70 vehicle types within EMFAC aligned to CEC categories used in the TEDF, which are collected for simplicity into the nine categories in Figure 19. Vehicle energy storage density improves annually across all EV types.<sup>62</sup>

Energy consumption for the vehicles are allocated into individual trips, with an activity model driven by surveyed usage data and calculated based on the payload of the vehicle type.<sup>63</sup> These data inform vehicle-specific models of driving and resting periods and the probability that a vehicle will need to recharge.

---

<sup>58</sup> CARB. Advanced Clean Truck Market Segment Analysis, February 22, 2019.  
<https://ww2.arb.ca.gov/sites/default/files/2019-02/190225actmarketanalysis.xlsx>

<sup>59</sup> CARB. [EMFAC](https://arb.ca.gov/emfac/). <https://arb.ca.gov/emfac/>.

<sup>60</sup> Populations for the Medium- and High Charging Demand cases within Table 9 reflect a modification to the December 3, 2020 draft Transportation Energy Demand Forecast cases, in which the catenary (direct electric) fuel type is excluded. Instead, trucks choose among zero-emission fuel types: battery or fuel cell EV.

<sup>61</sup> CARB. DRAFT Mobile Emissions Toolkit for Analysis (META), October 2, 2020.  
[https://ww3.arb.ca.gov/planning/sip/2020mss/draft\\_META.zip](https://ww3.arb.ca.gov/planning/sip/2020mss/draft_META.zip)

<sup>62</sup> Annual growth rates in gravimetric and volumetric energy densities are derived from [Bloomberg](#), [Tesla](#), and [Sila Nano](#).

<sup>63</sup> This includes time-based activity distributions from vehicles tested with portable activity monitoring systems in Southern California by the University of California, Riverside, for Energy Commission [agreement 500-15-002 with South Coast Air Quality Management District](#). More information is available at <https://ww2.energy.ca.gov/2019publications/CEC-500-2019-057/CEC-500-2019-057-AP.pdf>.

**Table 8: Comparison of Primary Input Parameters for HEVI-LOAD**

Scenario	Preliminary (August 2020)	Medium Charging Demand	High Charging Demand	Mobile Source Strategy
<b>BEV Population</b>	130,000 in 2030	75,000 in 2030	81,000 in 2030	180,000 in 2030
<b>Regional Populations Enhanced for Attainment</b>	South Coast Air Quality Management District Counties	Not Specified	Not Specified	Not Specified
<b>Payload Associated with Vehicle Type</b>	N/A (Assumed Electricity Consumption Rates)	3 choices, based on the relevant Weight Classes	Maximum GVWR for the relevant Weight Classes	Maximum GVWR for the relevant Weight Classes
<b>Battery Energy Density Improvement (%/year)</b>	None	7.2%	5.2%	5.2%

Source: CEC and Lawrence Berkeley National Laboratory

### Modeling Results

CEC and LBNL built upon a preliminary August 2020 analysis to estimate a range of charging infrastructure needs in 2030. The Medium Charging Demand scenario reflects a lower end of need as it combines BEV populations from the Mid Case TEDF, an optimistic rate of improvement in battery technology, and typical loading characteristics. In contrast, the High Charging Demand and the Draft Mobile Source Strategy scenarios reflect the potential for more extensive charging requirements resulting from heavily loaded operations and conservative improvements in battery technology. These latter two scenarios differ in their method to derive the 2030 population, with the first using an economic choice model and the second a scenario planning tool with the objective of reducing a certain volume of emissions. In the current structure of HEVI-LOAD, vehicles are provided two options: to charge overnight at 50 kilowatts (kW) or during the daytime at 350 kW, which is the maximum DC charging power supported by CCS without liquid cooling.

For the Draft Mobile Source Strategy scenario, the 180,000 MD/HD vehicles expected to be deployed in 2030 would require about 141,000 50 kW chargers and 16,000 350 kW chargers to complete the trips. Pursuant to AB 2127’s directive to meet the state’s ambient air quality standards and climate change goals, CEC features in Figure 19 the hourly load profiles of the nine aggregated vehicle categories for the Mobile Sources Strategy scenario. Charging profiles at the county-level indicate high variability in regional travel requirements and use cases.



**Figure 19: Projected On-Road Medium- and Heavy-Duty Vehicle Charging Load**

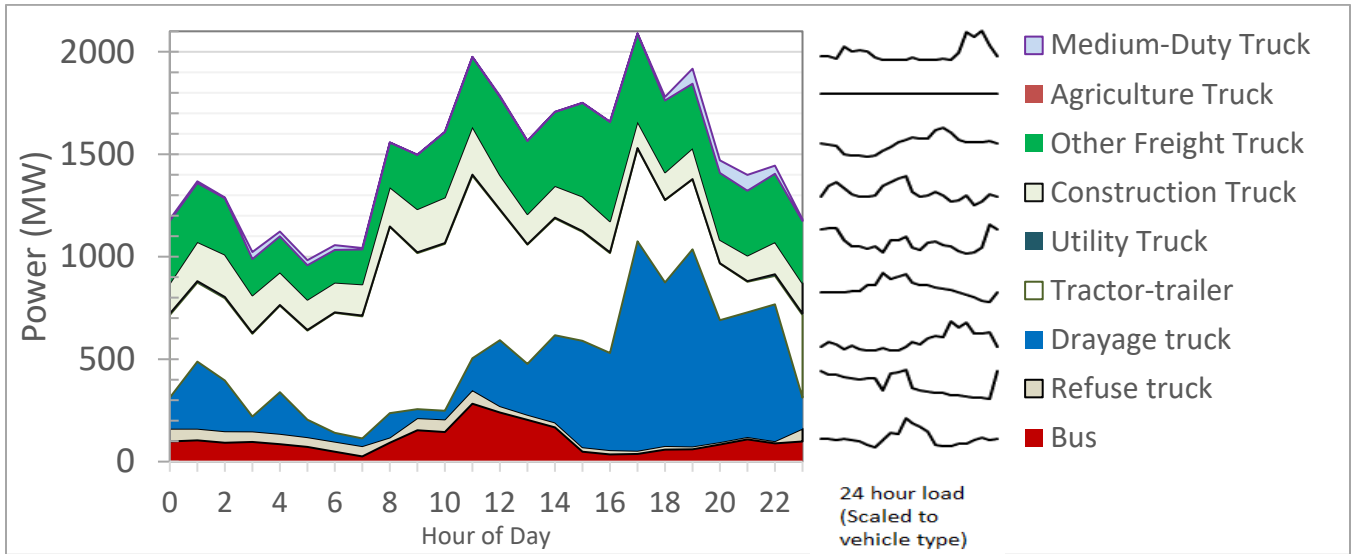

**The Draft Mobile Source Strategy scenario of the Medium- and Heavy-Duty Electric Vehicle Infrastructure Load, Operations, and Deployment (HEVI-LOAD) Tool illustrates the wide variation in the on-road vehicle duties and the potential for two gigawatts of evening charging requirements.**

Source: CEC and Lawrence Berkeley National Laboratory

**Future Refinements and Policy Implications**

CEC and LBNL continue to refine the HEVI-LOAD tool, including additional vehicle technology parameters, higher charging power options, and localized parameters for planning including parking and truck routes. Further, higher adoption within the South Coast Air Basin and San Joaquin Valley will be tailored toward faster adoption of ZEVs to meet more significant regulatory air quality targets using a method that accounts for how incentives or technology options affect vehicle choices. Future studies will examine specific requirements for commercial route schedules using a type of bottom-up analysis, agent-based activity simulation at the sub-hourly level, to determine interactions between the trucks and the road network. This will enable more granular exploration of grid infrastructure upgrade requirements and the potential for load flexibility with smart charging according to time-variant rates. Along with EVI-Pro, HEVI-LOAD will be critical to identifying and preparing for distribution or transmission grid constraints. A report discussing HEVI-LOAD findings is expected by mid-2021. The report will include county-level resolution of charger need. It will also include further detail on the inputs used in the model, the model’s methodology, and additional forecast scenarios out to 2035.

**EVSE Deployment and Grid Evaluation Model**

To properly distribute the PEV charging infrastructure necessary to meet California’s ZEV deployment goals, it is important to identify enough geographically distributed locations that

can economically host charging stations. The EDGE model is designed to help users focus charger deployment strategies and plan infrastructure investments to:

- Meet PEV travel demand charging needs.
- Achieve regional air quality improvement targets.
- Minimize PEV-related impacts to the electric grid.
- Ensure the equitable deployment of PEV chargers throughout the state.

As an analytical end point for CEC charging infrastructure analyses, EDGE will combine metrics and output results from varying data sources and models within four assessment domains: grid conditions, air quality, travel demand, and equity considerations. Each domain contains distinct barriers with complex relationships at the local level that highlight the need for unique infrastructure deployment solutions. EVI-Pro 2 charger quantities by type, location, and power level are used as the primary basis upon which data and analysis outputs from other domains are layered. Table 9 lists the evaluation criteria and data sources for each assessment domain within EDGE.

**Table 9: EDGE Domain Data Sources and Evaluation Criteria**

Domain	Data	Evaluation Criteria
G – grid conditions	IOU Integration Capacity Analysis (ICA) maps	Existing grid assets and integration capacity
A – air quality	California Department of Motor Vehicles populations, CEC GHG emission factors, CalEnviroScreen pollution data	Transportation GHG emission profiles
T – travel demand	EVI-Pro, California Statewide Travel Demand Model, Alternative Fuels Data Center	Electric vehicle trip density and travel-demanded charging
E – equity considerations	Senate Bill 1000 analysis, Location Affordability Index	Distribution of EVSEs within disadvantaged communities

Source: CEC

In terms of regional grid planning, EDGE will act as an “early warning system.” The algorithmic approach compares the load contribution from EVI-Pro charger results to capacities of existing state distribution grids to host new electricity loads. Where there is insufficient capacity to host new loads, this comparison shows a net capacity deficit. If there is a capacity deficit in a location, EDGE flags that location as needing an infrastructure upgrade.

## Modeling Results

Initial EDGE modeling focused on the grid conditions domain, and future iterations will incorporate air quality, travel demand, and equity domains. Preliminary results (Figure 20)

based on IOU Integration Capacity Analysis (ICA) maps show large areas of the grid with little to no excess capacity, as well as significant gaps in available utility grid data, largely in publicly owned utility (POU) territories. This analysis and accompanying maps can be updated as more utility distribution grid capacity information becomes available. For instance, recognizing that the ICA maps represent a monthly snapshot of a distribution system that must balance instantaneously and frequently changes (e.g. with switching, reconfiguration, and constant work to prepare upgrades), staff are incorporating additional data from the Grid Needs Assessment Reports that consider loading and generation conditions over a longer timeframe. EDGE can similarly be used to compare information from EVI-Pro 2 results to assess progress toward various targets and be one indicator of where charger deployment or capital investments should be focused.

**Figure 20: EDGE Capacity Analysis and Data Gaps**

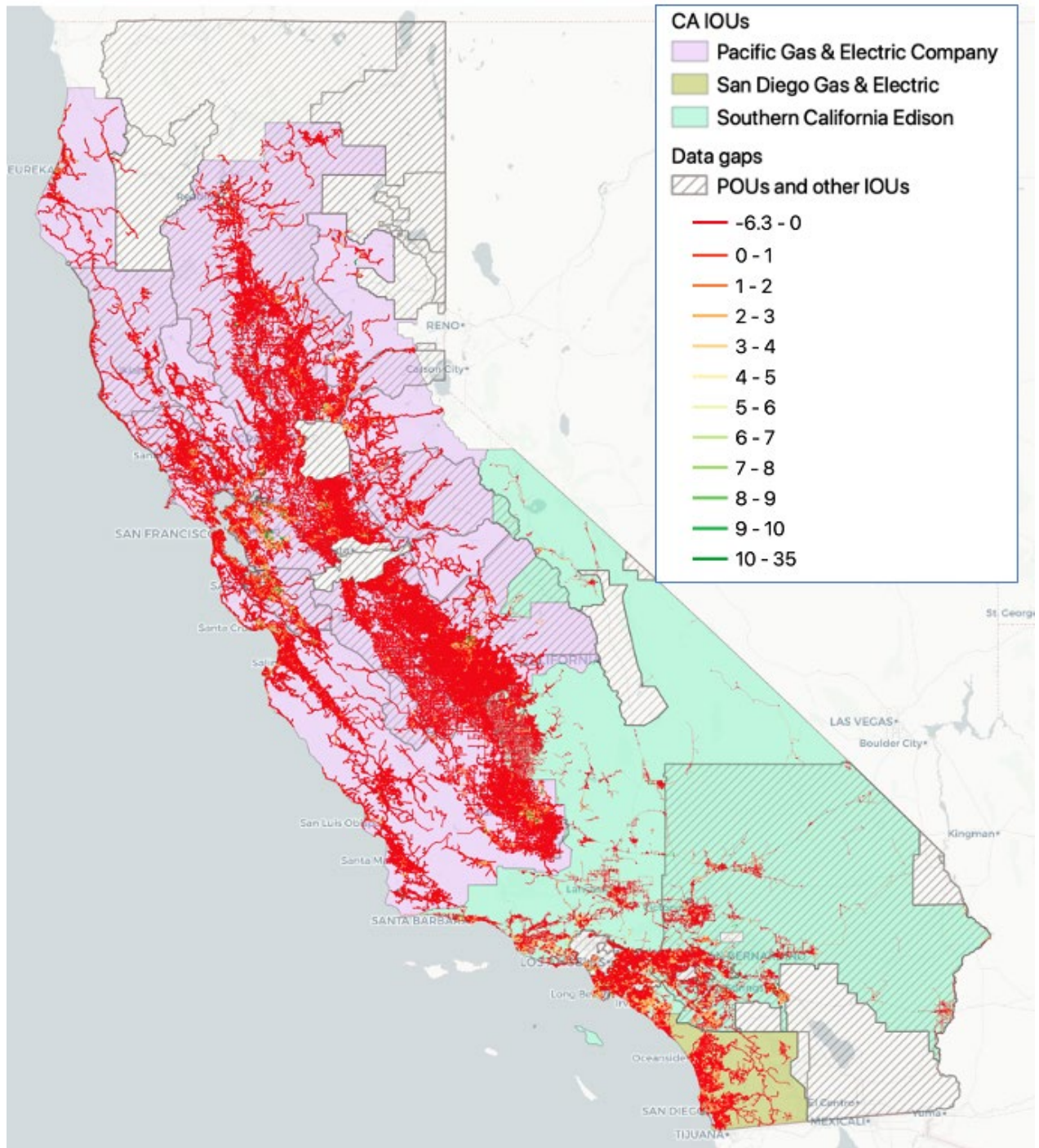

**Red lines indicate areas where the grid cannot accommodate additional load without any thermal or voltage violations. Grey hatched areas indicate regions where gaps in utility grid data exist (mostly in POU service areas). Colored lines, keyed in the legend, indicate the available circuit capacity in megawatts.**

Source: CEC

## **Policy Implications**

EDGE and other CEC modeling indicate that the make-ready infrastructure needed to support EVSEs requires special attention and investment. The costs that make up this investment include transformers, meters, breakers, wires, conduit, and associated civil engineering work. These costs are highly variable and difficult to predict. The extent of utility involvement is an important ongoing question.

Moreover, as medium- and heavy-duty electrification progresses (especially with CARB's new Advanced Clean Trucks and Innovative Clean Transit rules), existing make-ready infrastructure may need to serve higher-than-anticipated levels of charging load. Preliminary research suggests that most electric utilities in California have enough capacity in urban areas along the Interstate 5 corridor to support new medium-duty vehicle charging, but many rural areas and most heavy-duty charging stations will require local distribution grid upgrades, often including dedicated substations.<sup>64</sup> As an "early warning system" to help pinpoint the needs for these upgrades, EDGE can provide valuable assistance to transportation electrification planners.

## **Summary of Quantitative Modeling**

The CEC's array of quantitative modeling efforts analyze statewide charger needs for widespread electrification of light-duty intra-regional and inter-regional travel, TNC vehicles, MD/HD vehicles. They also track local grid capacity, air quality, travel demand, and equity considerations. Table 10 summarizes preliminary results from these quantitative models. Note that these results assume different vehicle populations in 2030 and do not account for chargers that can be used for two purposes, such as a short-distance and long-distance trips.

---

<sup>64</sup> West Coast Clean Transit Corridor Initiative. 2020.

**Table 10: Summary of Quantitative Modeling Preliminary Results**

Model Name	Preliminary Results
EVI-Pro 2	<p>Baseline scenario of 5 million ZEVs: Between 921,500 and 1,007,100 Level 2 and DC fast chargers needed at MUDs, workplaces, and public locations to support electrified intra-regional trips for light-duty vehicles in 2030. This includes 181,000-223,000 Level 1 and Level 2 chargers at MUDs, 710,000-752,000 public and workplace Level 2 chargers, and 30,500-32,100 DC fast chargers.</p> <p>High scenario of nearly 8 million ZEVs: Roughly a 50 percent increase in charging infrastructure needs. Between 1,467,100 to 1,594,900 chargers needed at MUDs, workplaces, and public locations. This includes 258,000 to 316,000 Level 1 and Level 2 chargers at MUDs, 1,156,000-1,223,000 public and work Level 2 chargers, and 53,100 to 55,900 public DC fast chargers.</p>
EVI-RoadTrip	Between 2,700 and 10,900 public DC fast chargers needed to support electrified inter-regional trips for 5 million light-duty ZEVs in 2030.
WIRED	Around 7,000 public DC fast chargers and 2,000 public Level 1 and Level 2 chargers needed in the Los Angeles, San Diego, and San Francisco regions to support electrified TNC vehicles in 2030.
HEVI-LOAD	Around 141,000 50 kW and 16,000 350 kW DC fast chargers needed to support electrified travel for 180,000 battery-electric MD/HD vehicles in 2030.
EDGE	Figure 20 illustrates analysis of existing IOU ICA maps.

Source: CEC

EVI-Pro 2 and EVI-RoadTrip project that California will need 933,000 Level 2 chargers and 35,000 DC fast chargers to support 5 million light-duty ZEVs by 2030. To reach a higher level of light-duty ZEV adoption, aligned with CARB’s Clean Miles Standard and the adoption level of nearly 8 million light-duty ZEVs by 2030 identified in their Draft Mobile Source Strategy, California will need 1.48 million Level 2 chargers and 69,000 DC fast chargers. In some cases, Level 1 chargers may be a sufficient substitute for Level 2 chargers serving MUDs or TNC vehicles.

# **CHAPTER 5:**

## **Meeting California’s Technological Charging Infrastructure Needs**

---

The previous chapter highlighted preliminary results from CEC models projecting that California will need between 923,000 and 1.01 million public and shared private chargers to meet the mobility demands of 5 million light-duty ZEVs, with an average projection of 968,000 chargers. Increasing electrification of MD/HD vehicles and equipment will further necessitate rapid charger deployment throughout the state. Chapters 5, 6, and 7 will discuss how California can meet these charging infrastructure needs and ensure that charging is accessible, equitable, smart, and convenient for all.

### **Pursue Greater Vehicle-Grid Integration to Support Grid Reliability, Provide Energy Resiliency, and Minimize Cost**

As discussed in Chapter 4, charging millions of vehicles will introduce significant load onto California’s electric grid (Figure 14). Widespread vehicle-grid integration is necessary to preserve grid reliability and ensure vehicles are charged with the cleanest and cheapest electricity possible. Vehicle-grid integration, which encompasses a suite of economic and technological tools to alter the charging behavior of PEVs, will help minimize driver charging costs, align charging with renewable energy generation, and even empower vehicles to supply stored energy to homes, businesses, or the grid.

#### **Smart Charging**

Smart charging, a basic form of vehicle-grid integration, involves reducing the power or shifting the timing of vehicle charging based on electricity pricing, carbon intensity,<sup>65</sup> demand response, or other grid signals while ensuring the driver’s range and departure time requests are met. Results from EVI-Pro 2 show that the vast majority of 2030 PEV charging will not naturally align with daytime solar generation. Instead, current projections indicate that electricity demand from vehicle charging will surge at midnight when off-peak electricity rates take effect, and when carbon-free electricity is not widely available. Despite the time flexibility afforded by nighttime charging, such an instantaneous spike in electricity demand may

---

<sup>65</sup> Carbon intensity refers to the level of carbon emissions associated with an activity, such as electricity generation. Low carbon intensity electricity means electricity which was generated with low levels of carbon emissions.

compromise grid reliability and necessitate investments in grid upgrades, particularly in urban areas.<sup>66</sup> Smart charging can mitigate these “timer spikes” by enabling vehicles to automatically shift or reduce charging based on local or system capacity,<sup>67</sup> while still ensuring the battery is sufficiently charged to meet the driver’s mobility needs. Further, smart charging can enable drivers to receive compensation for participating in such demand response programs.<sup>68</sup>

In addition to promoting grid reliability, smart charging can help integrate California’s growing renewable energy sources by aligning charging to times when solar or wind generation is abundant. Balancing authorities throughout the state, such as the California Independent System Operator (California ISO), must balance real time electricity generation and demand across the power system. Occasionally, renewable sources generate more power than is demanded by the grid, and these sources are temporarily shut off to prevent overloading the grid. For example, data from May 2019 indicate that the California ISO curtailed enough solar and wind generation to cover all the charging needs for every plug-in passenger car in California for the entire month.<sup>69</sup> Given that over 70% of vehicles are parked at home or work at noontime,<sup>70</sup> smart charging has the potential to promote greater coordination between vehicle charging and surplus renewable energy. In a future with widespread smart charging, utilities or other energy aggregators can use dynamic pricing or carbon intensity signals to automatically and seamlessly encourage vehicles to charge during periods of excess renewable generation, thereby maximizing the use of local clean energy.

Finally, smart charging can yield significant cost savings for drivers. By considering local electricity rates and the driver’s range requirements, the smart charging algorithm of a vehicle can automatically align charging with the lowest electricity prices while ensuring the battery is sufficiently charged by the driver-set departure time. These savings are not trivial: For a San Diego driver who would normally plug in at 5 p.m. after work, shifting all charging to San

---

66 In their joint smart charging project report, BMW and PG&E noted that “Nighttime charging can be more beneficial if the ‘timer peak’ is eliminated,” and that timer peaks “could increase the risk of grid instability,” particularly in urban areas. BMW and PG&E. (2017). “[BMW i ChargeForward: PG&E’s Electric Vehicle Smart Charging Pilot.](https://efiling.energy.ca.gov/GetDocument.aspx?tn=221489&DocumentContentId=29450)” <https://efiling.energy.ca.gov/GetDocument.aspx?tn=221489&DocumentContentId=29450>

67 The CPUC’s proposed decision concerning implementation of SB 676 identifies EV participation in demand response as a near-term policy action with broad support, and notes that “EV charging load’s demand responsiveness could be a source of local or system capacity ... through either a tariff-based mechanism or by allowing EVs to bid into resource adequacy markets.” CPUC. (November 2020). “[Proposed Decision Concerning Implementation of Senate Bill 676 and Vehicle-To-Grid Integration Strategies.](https://docs.cpuc.ca.gov/PublishedDocs/Efile/G000/M350/K963/350963223.PDF)” <https://docs.cpuc.ca.gov/PublishedDocs/Efile/G000/M350/K963/350963223.PDF>

68 Ibid.

69 Based on CEC analysis of CEC, DOT, and DOE vehicle data.

70 California Public Utilities Commission Energy Division, [Vehicle - Grid Integration: A Vision for Zero-Emission Transportation Interconnected throughout California’s Electricity System](#), March 2014.



Diego Gas & Electric's (SDG&E) "Super Off-Peak" hours can slash electricity costs by more than half.<sup>71</sup> While drivers can look up local electricity rates and manually set charging timers or plug and unplug their vehicles at the appropriate times, smart charging achieves the same cost savings automatically and consistently.

## **Bidirectional Charging**

Beyond smart charging, California should also encourage bidirectional technologies that allow PEVs to safely export stored battery energy. Most PEVs today are not equipped with bidirectional hardware, but bidirectional-capable vehicles — such as the recently announced Lucid Air,<sup>72</sup> Ford F-150,<sup>73</sup> and Rivian R1S and R1T<sup>74</sup> — could open new opportunities for cars to power homes and businesses, and provide grid support services in exchange for compensation. Vehicles capable of cleanly and quietly powering homes using the onboard battery can provide vital energy resiliency during grid outages, especially for communities affected by public safety power shutoffs. While the technologies to support such a setup exist, stakeholders must address several barriers before commercial vehicle-to-home solutions can become widely available, including vehicle-charger communication protocols, vehicle warranty agreements, and updated utility interconnection rules, among others. In the near term, CEC should support bidirectional charging by confirming paths for inverters designed for "mobile energy storage," including possibly leveraging the Energy Commission's Solar Equipment Lists, used to provide information and data that support existing solar incentive programs, utility grid connection services, consumers and state and local programs.<sup>75</sup> Creating streamlined

---

71 Based on SDG&E's TOU-DR1 rate schedule as of July 2020.

72 The Lucid Air will feature "full bi-directionality for advanced Vehicle-to-Everything (V2X)." Lucid Motors. Accessed November 2020. "[Lucid Air to be the Fastest Charging EV, Featuring a 900V+ Architecture Delivering a Charging Rate of up to 20 Miles Per Minute.](https://www.lucidmotors.com/media-room/lucid-air-fastest-charging-ev/)" <https://www.lucidmotors.com/media-room/lucid-air-fastest-charging-ev/>.

73 The Ford F-150 will feature bidirectional power transfer. Wall Howard, Phoebe, "[Ford reveals plan for \\$700M plant, jobs at Rouge plus all-electric Ford F-150 secrets,](https://www.freep.com/story/money/cars/ford/2020/09/17/ford-invests-rouge-electric-f-150-uaw/5819541002/)" Detroit Free Press, September 17, 2020. <https://www.freep.com/story/money/cars/ford/2020/09/17/ford-invests-rouge-electric-f-150-uaw/5819541002/>

74 Rivian vehicles will be capable of "Rivian-to-Rivian" charging. Evans, Sean. "[The Drive Interview: Rivian Automotive Founder and CEO RJ Scaringe,](https://www.thedrive.com/tech/28323/the-drive-interview-rivian-automotive-founder-and-ceo-rj-scaringe)" June 5, 2019. <https://www.thedrive.com/tech/28323/the-drive-interview-rivian-automotive-founder-and-ceo-rj-scaringe>

75 The CEC's Solar Equipment Lists include equipment that meets established national safety and performance standards.

interconnection pathways that accommodate both AC<sup>76</sup> and DC<sup>77</sup> vehicle discharge will promote rapid growth of bidirectional technologies.

In addition to offering better energy resiliency, bidirectional solutions enable controlled charge and discharge cycles, as opposed to smart charging, whose beneficial grid interaction ends when the car batteries are charged. Thus, bidirectional technologies unlock greater revenue-generating opportunities for vehicles to aid and support the grid. For example, a utility program could offer bill credits in exchange for responding to signals requesting that vehicles discharge power to the grid to alleviate local congestion. Another program could compensate homeowners for switching from grid power to vehicle battery power during periods of extreme electricity demand. Such programs could significantly reduce vehicle ownership costs for drivers while reducing grid infrastructure upgrade costs and improving system reliability. The CEC's *2021 Vehicle-Grid Integration Roadmap Update*, expected in early 2021, will discuss the necessary policy and technological steps to realize a future where programs and vehicles supporting vehicle-grid integration are widely available.

## **Prioritize Standardized and Interoperable Charger Connectors and Communications**

Despite years of market experimentation, charger connectors and communication protocols remain fragmented across all types of PEVs. This lack of consistency needlessly inconveniences existing PEV drivers, feeds confusion among prospective PEV buyers, and threatens to significantly hinder widespread vehicle-grid integration. Where possible, state agencies and policy makers should leverage procurement requirements, funding opportunities, or other market signals to accelerate market unification around interoperable connectors and communication protocols.

---

76 On AC V2G, the 2019 IEPR at 112 notes that CPUC's Vehicle-to-Grid Alternating Current Subgroup recommends exploring the development of lists to authenticate and authorize certified PEVs to safely discharge to the grid and to analyze policy implications of multi-utility and cross-state electrical and inverter certification issues. CEC. 2019. [2019 Integrated Energy Policy Report](https://www.energy.ca.gov/data-reports/reports/integrated-energy-policy-report/2019-integrated-energy-policy-report). <https://www.energy.ca.gov/data-reports/reports/integrated-energy-policy-report/2019-integrated-energy-policy-report>.

77 On DC V2G, ordering paragraphs 38-39 of CPUC Decision 20-09-035 clarify that "Rule 21 applies to the interconnection of stationary and mobile energy storage systems," and that "equipment with stationary inverter for direct current charging of vehicles may be interconnected under the current Rule 21 language if the EVSE meets Rule 21 requirements." CPUC. September 2020. "[Decision 20-09-035](https://docs.cpuc.ca.gov/PublishedDocs/Published/G000/M347/K953/347953769.PDF)." <https://docs.cpuc.ca.gov/PublishedDocs/Published/G000/M347/K953/347953769.PDF>

## Standardizing Charger Connectors

Charging connectors are the most prominent and readily apparent example of market fragmentation in PEV charging. DC fast charging connectors for passenger cars are split among three designs—CCS, CHAdeMO, and Tesla—even though all serve effectively the same purpose. For a driver, this means that fast charging requires not only finding a nearby station, but verifying whether that charging station has a connector compatible with his or her vehicle. Alternatively, some drivers may be able to purchase adapters to fast charge using other connector standards, but these adapters can cost several hundred dollars — an expense that exists only due to market fragmentation.

The presence of multiple fast charging standards also increases the hardware complexity of charging stations and impedes high charger usage. Indeed, EVI-RoadTrip, which models the number and location of fast chargers to support interregional travel, assumes a unified fast charging standard such that any vehicle could use any fast charger. In the real world, the continued lack of standardization would increase the number of fast chargers needed to meet California’s mobility demands and necessitate more financial investment, more planning, and more time — yet yielding no additional emissions reductions, electric miles enabled, or any tangible benefit. Unification around a common connector standard will reduce overall network cost, improve convenience, and maximize access to charging – regardless of the driver’s vehicle make or model.

Fortunately, North American market players appear to be rapidly unifying around CCS,<sup>78</sup> with Nissan announcing that its upcoming electric crossover will be equipped with a CCS inlet (rather than CHAdeMO).<sup>79</sup> Separately, CARB announced that it would begin developing rules that would require light-duty vehicles with fast-charging capability sold in California to be compatible with the CCS connector, beginning with Model Year 2026.<sup>80</sup> CEC should align technical requirements in applicable programs and funding opportunities with the market direction.

Lack of connector standardization is even more prevalent among MD/HD vehicles. The nascency of this market may present opportunities to more aggressively encourage

---

78 Analysis by CARB shows that by 2022, 51 of the 59 BEV models expected to be available in California will use the CCS inlet. CARB. 2020. "[Public Workshop Advanced Clean Cars II.](https://ww2.arb.ca.gov/sites/default/files/2020-09/ACC%20II%20Sept%202020%20Workshop%20Presentation%20%28Updated%29.pdf)" <https://ww2.arb.ca.gov/sites/default/files/2020-09/ACC%20II%20Sept%202020%20Workshop%20Presentation%20%28Updated%29.pdf>.

79 Goodwin, A. July 15, 2020. "[Nissan Adopts CCS Fast-Charging With New Ariya Electric SUV.](https://www.cnet.com/roadshow/news/nissan-ariya-electric-suv-adopts-ccs-fast-charging/)" Road Show by C|Net. <https://www.cnet.com/roadshow/news/nissan-ariya-electric-suv-adopts-ccs-fast-charging/>

80 CARB. 2020. "[Public Workshop Advanced Clean Cars II.](https://ww2.arb.ca.gov/sites/default/files/2020-09/ACC%20II%20Sept%202020%20Workshop%20Presentation%20%28Updated%29.pdf)" <https://ww2.arb.ca.gov/sites/default/files/2020-09/ACC%20II%20Sept%202020%20Workshop%20Presentation%20%28Updated%29.pdf>.

standardization earlier on, however. Many manufacturers of plug-in MD/HD vehicles use proprietary connectors that are incompatible between different vehicles, and vehicle operators have repeatedly voiced frustration about the lack of interoperability and the need to coordinate certain vehicles with specific chargers.<sup>81</sup> These concerns are especially pronounced for fleets that operate multiple equipment types, such as in cargo-handling environments where several types of vehicles from different manufacturers may be in operation on a given day. While some manufacturers repurpose light-duty connectors such as CCS for use with MD/HD vehicles, many high-power standards designed specifically for the MD/HD sector remain under development, including CharIN's conductive connector for megawatt-level charging<sup>82</sup> and SAE's J2954 for wireless charging.<sup>83</sup> While MD/HD vehicles will likely use a wide array of charging interfaces (for example, conductive connector, automated pantograph, or wireless), the state should prioritize charger deployments that use standardized and interoperable implementations wherever appropriate.

Table 11 shows a selection of existing and under-development charging connector standards for light-duty and MD/HD applications.







---

81 Panel discussion. May 2020. "[IEPR Workshop on Heavy-Duty Zero-Emission Vehicle Market Trends](https://efiling.energy.ca.gov/getdocument.aspx?tn=233610)." <https://efiling.energy.ca.gov/getdocument.aspx?tn=233610>.

82 The National Renewable Energy Laboratory recently hosted a test event for the Megawatt Charging System. Source: NREL. October 12, 2020. [NREL-Hosted Event Supports Industry Development of Megawatt Charging System Connectors](https://www.nrel.gov/news/program/2020/nrel-hosted-event-supports-industry-development-megawatt-charging-system-connectors.html). <https://www.nrel.gov/news/program/2020/nrel-hosted-event-supports-industry-development-megawatt-charging-system-connectors.html>.

83 SAE J2954-2 for heavy-duty vehicles is a work in progress. Source: SAE International. October 25, 2013. [Wireless Power Transfer of Heavy Duty Plug-In Electric Vehicles and Positioning Communication](https://www.sae.org/standards/content/j2954/2/). <https://www.sae.org/standards/content/j2954/2/>.

**Table 11: Existing and Upcoming Charging Connector Standards**

Diagram	Connector Standard	Maximum Output Power	Application Notes
	SAE J1772	19.2 kW AC <sup>84</sup>	Used for Level 1 and Level 2 charging in North America. Commonly found on home, workplace, and public chargers.
	CCS	450 kW DC <sup>85</sup>	Used for DC fast charging most vehicle models in North America. Generally installed at public chargers.
	CHAdeMO	400 kW DC <sup>86</sup>	Used for DC fast charging select vehicles models in North America. Generally installed at public chargers.
	Tesla	22 kW AC <sup>87</sup> 250 kW DC <sup>88</sup>	Used for both AC and DC fast charging for Tesla models only.
	SAE J2954	22 kW light-duty, 200 kW heavy duty <sup>89</sup>	Wireless power transfer. Standard for MD/HD vehicles is under development.
	SAE J3105	>1 MW <sup>90</sup>	Automated connection device to charge MD/HD vehicles. Variants include pantograph up or down and pin-and-socket.
	CharIN Megawatt Charging System	4 MW <sup>91</sup>	Conductive MW-level charging for MD/HD vehicles. Standard is under development.

Source: CEC

84 U.S Department of Energy Alternative Fuels Data Center. "[Developing Infrastructure to Charge Plug-In Electric Vehicles.](https://afdc.energy.gov/fuels/electricity_infrastructure.html)" [https://afdc.energy.gov/fuels/electricity\\_infrastructure.html](https://afdc.energy.gov/fuels/electricity_infrastructure.html).

## Standardizing Charger Communication Protocols

Beyond the physical connector, the market has also been slow to adopt standardized communication protocols between the vehicle and charger, and between the charger and network. All chargers equipped with a J1772 connector for AC charging today are capable of rudimentary vehicle-to-charger “low-level” communications using a pulse-width modulated signal over the electrical connection. This signaling scheme communicates basic information, such as requested and available charge current, but is not capable of “high-level” communications such as the driver’s mobility needs, scheduling, electricity pricing, vehicle discharge commands, or authentication and billing. Current methods for charge session payment and vehicle-grid integration must be handled through external means, often requiring a separate smartphone app, membership cards, manual input from the driver, vehicle telematics, or an unwieldy combination of the above. Put another way, the existing signaling scheme does not offer drivers a maximally convenient charging experience and is insufficient to support vehicle-grid integration at scale.

Many automakers and charging networks have publicly signaled their intention to adopt International Organization for Standardization (ISO) 15118 as a more robust digital communications protocol between the vehicle and charger.<sup>92</sup> Crucially, ISO 15118 provides a common language for vehicles and chargers to exchange information about authentication, billing, and information to promote vehicle-grid integration. For example, ISO 15118’s “Plug and Charge” feature will enable drivers charging away from home to securely initiate and pay

---

85 CharIn. 2020. “[Mapping Standards for Low- and Zero-Emission Electric Heavy-Duty Vehicles](#),” presentation. International Transportation Forum February 18-20, 2020 Workshop. <https://www.itf-oecd.org/sites/default/files/docs/charging-infrastructure-standardisation-developments-bracklo.pdf>.

86 CHAdeMO. “[Technology Overview](#).” <https://www.chademo.com/technology/technology-overview/>.

87 Tesla Motors. 2015. [Form 10-K](#). Edgar Online. <http://large.stanford.edu/courses/2015/ph240/romanowicz2/docs/tesla-annual.pdf>.

88 Tesla Motors. 2019. “[Introducing V3 Supercharging](#).” <https://www.tesla.com/blog/introducing-v3-supercharging>.

89 SAE. 2013. “[Wireless Power Transfer of Heavy Duty Plug-In Electric Vehicles and Positioning Communication J2954/2 Standard](#)”. <https://www.sae.org/standards/content/j2954/2/>.

90 CharIn. 2020. “[Mapping Standards for Low- and Zero-Emission Electric Heavy-Duty Vehicles](#),” presentation. International Transportation Forum February 18-20, 2020 Workshop. <https://www.itf-oecd.org/sites/default/files/docs/charging-infrastructure-standardisation-developments-bracklo.pdf>.

91 Ibid.

92 Many automakers have stated their intention to implement ISO 15118 for charger communications. Source: OEM Group. January 13, 2017. “[OEM Consolidated Comment to CEC VGI Communications Standard Workshop 7 December 2016](#).” <https://efiling.energy.ca.gov/GetDocument.aspx?tn=215326&usg=AOvVaw2ECiPPrOLaFkr8K55QBlaG>.

for a charging session simply by plugging in their vehicle. User authentication and billing are processed automatically in the background without the need for scanning a membership card, tapping through app menus, or swiping a credit card. Plug and Charge will make charging even easier than refueling at a gas pump, and numerous market players have announced their intention to introduce this feature in upcoming products, including Audi,<sup>93</sup> BMW, Daimler, Ford,<sup>94</sup> Lucid Motors, Porsche, and others.

Perhaps more importantly, ISO 15118 provides a standardized method for vehicles and chargers to communicate the information needed to enable smart and bidirectional charging. Smart charging algorithms require information about the driver's requested range, estimated departure time, utility electricity rates, power availability, and local demand response events to optimize around both the driver and the grid. Similarly, bidirectional charging requires the vehicle and charger to exchange information about power limits, power transfer method (such as AC, DC, or wireless), and local grid parameters.

ISO 15118 is the single protocol that accommodates communications for all the use cases above. Widespread standardization around ISO 15118 will help ensure that the greatest number of vehicles and chargers can exchange the information necessary for vehicle-grid integration. While automakers or charger manufacturers can implement vehicle-grid integration capabilities using custom, proprietary protocols, these implementations are often not compatible among different vehicle or charger models, meaning that drivers interested in smart charging or vehicle-to-home would be restricted to certain market players. That outcome restricts choice, competition, and scale. A future where all Californians have access to smart charging and bidirectional features such as vehicle-to-home discharge — regardless of vehicle type, charger model, or utility territory — requires a common language for vehicle-to-charger communication. Given that many global automakers and charging networks have already announced their intention to adopt ISO 15118 for vehicle-to-charger communications, CEC should prioritize deploying ISO 15118-ready charging hardware to ensure maximum preparedness for future vehicles and vehicle-grid integration features.

Similarly, standardized charger-to-network communications using the Open Charge Alliance's Open Charge Point Protocol (OCPP) gives charger operators and site hosts greater flexibility and control over their chargers. Network management systems provide site hosts a centralized way to connect and communicate with a portfolio of chargers. Through the back-end network management software, hosts can monitor charger status, connect chargers to signals for local

---

93 In a [joint comment](#) to the CPUC, Audi, BMW, Daimler, Lucid, Porsche, and VW stated their intention to implement ISO 15118 on their future vehicles, including the Plug and Charge feature. <https://www.cpuc.ca.gov/WorkArea/DownloadAsset.aspx?id=6442457082&usg=AOvVaw397WEvjy9d6c7n-6nZhrFY>.

94 Ford's Mustang Mach-E will feature Plug and Charge Source: Ford. [Convenience on the Road](#). <https://www.ford.com/buy-site-wide-content/overlays/mach-e-overlays/convenience-on-the-road/>.



electricity pricing and demand response, and even set up a reservation system to allocate time slots to users. OCPP provides a common language to promote this communication between chargers and the network management system and is already the de-facto standard for charger-network communication.<sup>95</sup> Generally, any charger that is OCPP-compliant will work with any back-end network that is also OCPP-compliant.<sup>96</sup> With widespread charger-network interoperability, hosts are free to manage a mixed portfolio of charging hardware under a single networking solution, regardless of the model or manufacturer of each charger. Furthermore, hosts can “shop around” for back-end network solutions based on features, convenience, or price. This two-way flexibility ensures that hosts are never locked into any single back-end network or a charger manufacturer, thus minimizing the risk of stranded assets and spurring marketplace competition.

ISO 15118 and OCPP are key protocols that fill two communication gaps critical to achieving convenient, grid-integrated charging. As shown in Figure 21, grid-responsive charging requires coordination and negotiation among many stakeholders, with each arrow representing an exchange of data needed to complete the charging transaction. Standardized communication protocols minimize barriers to this exchange of information and ensure that the process is maximally automated without requiring deep knowledge or involvement from the driver. Given the capabilities and growing use of both ISO 15118 and OCPP, CEC should prioritize deploying chargers that support both standards. CEC staff anticipate publishing a report in the second quarter of 2021 which will outline strategies to encourage and enable hardware and software standardization.

---

95 Rodríguez-Serrano et al. (2013). *A communication system from EV to EV Service Provider based on OCPP over a wireless network*. <https://ieeexplore.ieee.org/document/6700020> and Neaimeh, M., Andersen, P.B. Mind the gap- open communication protocols for vehicle grid integration. *Energy Inform* 3, 1 (2020). <https://doi.org/10.1186/s42162-020-0103-1>

96 Under the Open Charge Alliance’s certification program, a charger is OCPP-compliant only if it successfully communicates with at least two OCPP-compliant networks. Source: Siemens. “[Charging With OCPP Standards](https://assets.new.siemens.com/siemens/assets/api/uid:11c56240-64b2-4977-8f8c-0e418dfb2a33/sids-t40036-00-4aus-lo-res.pdf).” <https://assets.new.siemens.com/siemens/assets/api/uid:11c56240-64b2-4977-8f8c-0e418dfb2a33/sids-t40036-00-4aus-lo-res.pdf>.



**Figure 21: Grid-Integrated Charging Equipment Design Archetype**

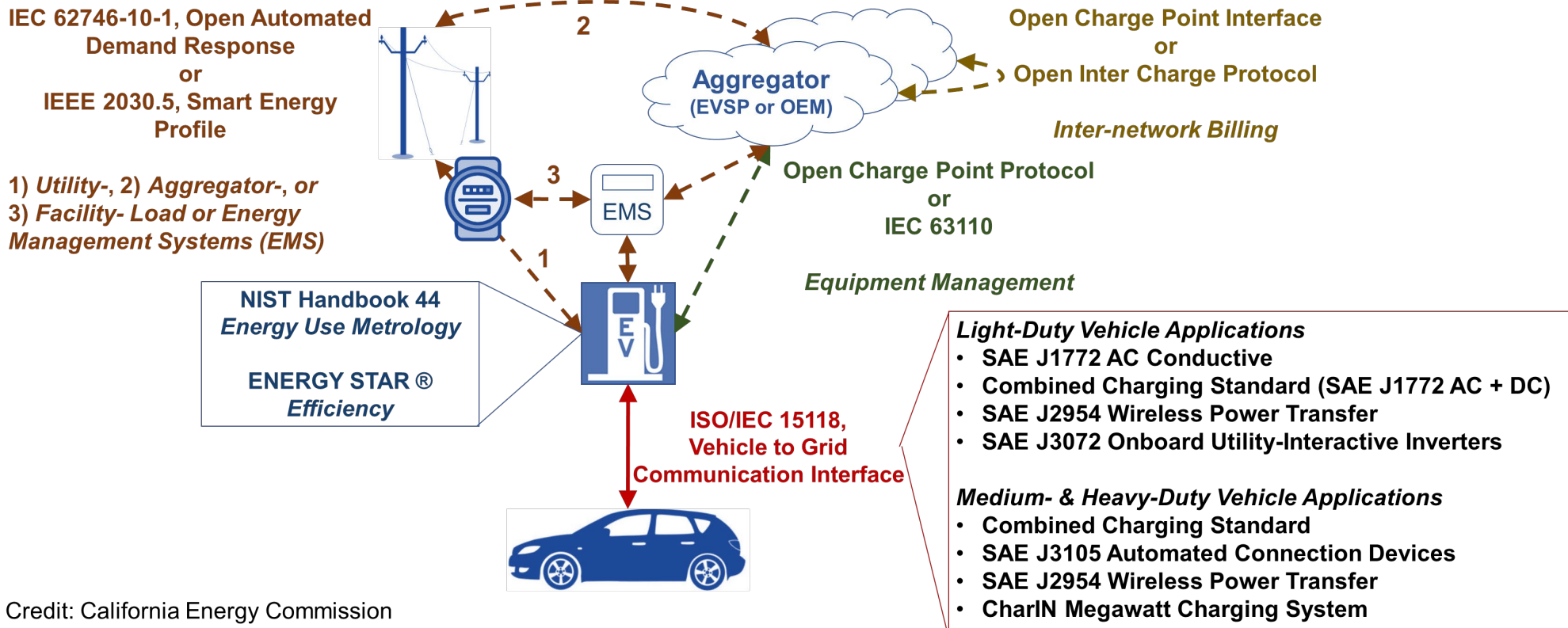

Credit: California Energy Commission

**Interoperable charging hardware is critical to a charging experience that is user-friendly and grid-responsive. ISO 15118 provides a standard vehicle-charger communication language, while OCPP provides a standard charger-network language. Widespread deployment of chargers that “speak” these languages will ensure that California is prepared for vehicle-grid integration, as well as future vehicle and charger features.**

Source: CEC

# CHAPTER 6:

## Planning for California’s Local and Community Charging Infrastructure Needs

---

### Tailor Charging Solutions So That Their Form Factors Match Local Needs

While charging should incorporate standardized connectors and communication protocols, individual charger deployments must also meet the needs of the local community, built environment, and use case. There is no one-size-fits-all charging solution. Local land use, available electrical capacity, expected charger use, space constraints, the presence of distributed energy resources, and many other factors determine the most appropriate solution for a charging installation. Generally, the best fit charging solution maximizes the electric miles enabled at the lowest overall cost while reflecting local needs and constraints.

For instance, grid-tied pedestal chargers may be commonplace in office parks and suburban malls today, but a mobile unit capable of charging multiple vehicles throughout the day could be the optimal solution for a parking deck where electrical upgrades would be cost-prohibitive. In remote areas with no or limited grid service, or for hosts who want to avoid construction permitting, a drop-in charger canopy with integrated solar and battery storage could offer the cheapest and fastest way to provide charging. Examples of chargers suited to each of these situations are illustrated in Figure 22. These innovative and unique charging products may offer significant avoided cost benefits that are not apparent when simply comparing products based on upfront cost. However, such products often do not fit neatly into existing charging infrastructure funding programs, and the CEC is exploring funding approaches that better recognize and account for avoided cost benefits.<sup>97</sup>

---

97 CEC. "[GFO-20-605 — BESTFIT Innovative Charging Solutions.](https://www.energy.ca.gov/solicitations/2020-08/gfo-20-605-bestfit-innovative-charging-solutions)" [https://www.energy.ca.gov/solicitations/2020-08/gfo-20-605-bestfit-innovative-charging-solutions.](https://www.energy.ca.gov/solicitations/2020-08/gfo-20-605-bestfit-innovative-charging-solutions)

**Figure 22: Examples of Different Charger Form Factors Based on Local Environment**



The best-fit charging solution depends on the needs of the local community, built environment, and use case. Pedestal chargers (left) are common today, and generally require a grid connection and construction permitting. FreeWire’s Mobi chargers (middle) can move about and charge multiple vehicles throughout the day, and can be recharged on a standard household outlet when not in use. Beam’s charging canopy (right) integrates solar and battery storage and can be fitted on existing parking spaces without additional electrical infrastructure or permitting.

Source: CEC, FreeWire Technologies, Beam Global

## **Use Community-Centric Planning to Serve Local and Community Needs and Foster Equitable Outcomes**

Historically, transportation planning and projects have often insufficiently considered the needs of the local community, particularly low-income and disadvantaged communities suffering disproportionate health impacts.<sup>98</sup> To ensure the benefits of electrification are equitably distributed, policymakers must directly involve communities in identifying and planning high quality charging solutions that meet local needs and yield direct community benefits. In its 2019 *Mobility Equity Framework*,<sup>99</sup> the Greenlining Institute recommends that planners involve communities through strategies such as participatory budgeting<sup>100</sup> and ensuring that community members have decision-making authority throughout the project process. Additionally, to ensure broad community inclusion and participation, CARB recommends compensating those attending community outreach events, providing transportation to such events where appropriate, and engaging in targeted outreach to hard-to-reach residents.<sup>101</sup>

---

98 Greenlining Institute. (2018). [Mobility Equity Framework](https://greenlining.org/wp-content/uploads/2019/01/MobilityEquityFramework_8.5x11_v_GLI_Print_Endnotes-march-2018.pdf). [https://greenlining.org/wp-content/uploads/2019/01/MobilityEquityFramework\\_8.5x11\\_v\\_GLI\\_Print\\_Endnotes-march-2018.pdf](https://greenlining.org/wp-content/uploads/2019/01/MobilityEquityFramework_8.5x11_v_GLI_Print_Endnotes-march-2018.pdf)

99 Ibid.

100 According to the Greenlining Institute, “In participatory budgeting, community members democratically decide how to spend part of a public budget. Because the process facilitates residents brainstorming project ideas to address their needs, this is generally more robust than other community needs assessments.”

101 CARB. “[STEP Community Inclusion Guidance](https://ww3.arb.ca.gov/msprog/step/step_community_inclusion_guidance.pdf).” [https://ww3.arb.ca.gov/msprog/step/step\\_community\\_inclusion\\_guidance.pdf](https://ww3.arb.ca.gov/msprog/step/step_community_inclusion_guidance.pdf)

One key tool to identify local needs and challenges, as well as promote equitable charging infrastructure deployment, is an EV community blueprint. Local governments or similar jurisdictions gathered teams that often included community-based organization to apply for a CEC-funded grant for up to \$200,000 to develop EV community blueprints. These blueprints outline local policies, actions, and measures to prepare for and accelerate widespread vehicle electrification. The CEC has awarded grant funding for blueprint development to multiple jurisdictions throughout the state, including the City of Sacramento, the County of Los Angeles, and the Port of Long Beach.

To highlight one example, Ventura County brought together “over 25 stakeholders representing local governments, Port of Hueneme, workforce development interests, affordable housing authorities, commercial property management companies, community-based organizations, and nonprofit advocates.”<sup>102</sup> The coalition reached out to hundreds of employers, property managers, county employees, and members of the public, including Spanish-speakers and parents of school-age children. Across the blueprints, public outreach (ranging from workshops to surveys to ride-and-drive events where participants can get inside an EV) emerged as a key tool to understand community needs and inform members of available incentives, rebates, and charging accessibility.

Fresno’s blueprint, which a team led by Tierra Resource Consultants developed, focused on the charging infrastructure needs of those who live in multi-unit dwellings (MUDs). There is much less access to residential charging at MUDs<sup>103</sup>, which account for about 40% of the State’s housing stock and where the State’s low-income residents are more likely to live<sup>104</sup>. Along with identifying market, policy, and economic barriers to ZEV adoption for low-income and/or MUD tenant Californians, the blueprint identifies a community engagement framework based on supporting the ability of communities to drive the development process to install chargers at their residences or nearby commercial locations. This type of community-centric demand development is a crucial complement to the modeling detailed in Chapter 4.

Many blueprints also identified the need for multimodal transportation hubs that provide EV charging alongside existing bus terminals, park-and-ride lots, and commuter trains to encourage EV usage and adoption. Other tools featured in the blueprints include local and regional government procurement of EVs and setting local goals that align with those of the state.

---

102 VCREA, Community Environmental Council, and EV Alliance staff. 2019. [Ventura County Electric Vehicle Ready Blueprint](https://s29552.pcdn.co/wp-content/uploads/Ventura-County-EV-Ready-Blueprint_July-2019.pdf). [https://s29552.pcdn.co/wp-content/uploads/Ventura-County-EV-Ready-Blueprint\\_July-2019.pdf](https://s29552.pcdn.co/wp-content/uploads/Ventura-County-EV-Ready-Blueprint_July-2019.pdf).

103 Nicholas, Michael, Dale Hall, Nic Lutsey. 2019. [Quantifying The Electric Vehicle Charging Infrastructure Gap Across U.S. Markets](https://theicct.org/sites/default/files/publications/US_charging_Gap_20190124.pdf). [https://theicct.org/sites/default/files/publications/US\\_charging\\_Gap\\_20190124.pdf](https://theicct.org/sites/default/files/publications/US_charging_Gap_20190124.pdf)

104 Keneipp, Floyd, Nicholas Synder, Natalie Mezaki, Cory Welch. 2019. *EV Ready Low-Income Multifamily Community Blueprint*.

The ongoing second phase of the CEC's Electric Vehicle Ready Communities Blueprint solicitation will provide up to \$7.5 million in funding for communities to implement the projects they describe in their blueprints, such as those discussed in the paragraphs above.<sup>105</sup>

## **Building Codes are a Crucial Policy Tool to Deploy Sufficient Charging Infrastructure**

Building codes are often a cost-effective tool to support state policy, ensure equitable outcomes, and reduce barriers to adoption. Increased charging options at MUDs are needed to ensure that all Californians have access to convenient charging. This is all too often an issue at apartments, condos, and for renters where the motivations of tenants and landlords do not always align. Building codes that address new construction as well as major renovations to existing buildings such as when new parking is added or during repaving of an existing parking lot can materially address the EV charging infrastructure gap.

Many city and county governments are using their authority over building codes to increase EV adoption and decrease the cost of charging infrastructure. They can be either "reach" goals or mandated. Building codes are an important tool in supporting Executive Order N-79-20 and should be updated to ensure broad access to ZEV infrastructure for all Californians. Some local codes have already incorporated items such as the following:

- Distribution-level grid upgrades to make parking spaces "EV-ready" during new construction or major renovation, particularly for multiunit dwellings (mandatory and reach).
- Charger installations, particularly at multiunit dwellings (mandatory and reach).
- Load-management systems that allow multiple chargers to share one electrical connection (reach).

As recognized in assessments by state agencies, it may not be enough to focus solely on new buildings. Codes that address alterations and additions of existing buildings would likely result in significant increases in TE infrastructure.<sup>106</sup> In fact, new construction represents about one

---

<sup>105</sup> CEC. "[GFO-19-603 - Electric Vehicle Ready Communities Phase II- Blueprint Implementation.](https://www.energy.ca.gov/solicitations/2020-08/gfo-19-603-electric-vehicle-ready-communities-phase-ii-blueprint)"  
<https://www.energy.ca.gov/solicitations/2020-08/gfo-19-603-electric-vehicle-ready-communities-phase-ii-blueprint>.

<sup>106</sup> California Public Utilities Commission, Draft Transportation Electrification Framework, page 122.

percent of total nonresidential buildings. Only about 10 percent of nonresidential buildings are projected to be EV capable by 2030 if building standards are limited to new construction.<sup>107</sup>

## **Recognize and Prepare for Greater Complexities With Medium- and Heavy-Duty Infrastructure Planning**

While private light-duty vehicles typically see extended periods of downtime and have flexible usage requirements, medium- and heavy-duty vehicles often adhere to demanding operation patterns that make infrastructure planning for these vehicles a unique challenge. California's medium- and heavy-duty vehicles cover a broad spectrum of duty cycles and use cases, including passenger travel, goods movement, port cargo handling, long-distance transport of refrigerated goods, and urban delivery, among many others. Electrifying the medium- and heavy-duty sector is especially critical because of the disproportionate air pollution impact to communities near ports, and major trucking corridors. Improving these conditions will require solutions beyond simply scaling up light-duty chargers. Charging infrastructure planning for the medium- and heavy-duty sector requires close attention to the specific vehicle uses and environments, high-power charging demands, lack of consistency in charging connectors, and landlord-tenant relationships.

Each vehicle operator's requirements for power, uninterrupted runtime, load type, and downtime available for refueling directly affect the design and sizing of the appropriate charging hardware. A charger for charging a school bus overnight would be insufficient for a heavy-duty forklift with only a few hours of total downtime each day. Furthermore, the specific operating site of a vehicle may introduce unique constraints to charger selection, such as spacing and clearance concerns, work rules governing plugging and unplugging vehicles, and limitations on available electrical capacity for charging. The result of such operator-specific complexities is that the most appropriate charger type—whether it be a conductive connector charger, pantograph, or wireless charger—may vary significantly from site to site, even for ostensibly similar vehicles.

To illustrate this point, in 2017, the CEC awarded around \$8 million each to the Port of Long Beach and the Port of Los Angeles for charging infrastructure deployments to support new battery-electric yard tractors. While both projects received roughly the same amount of funding for charging infrastructure, each project allocated funds very differently to match their operating demands. The Port of Long Beach spent \$6.7 million on construction and service upgrades alone, while the Port of Los Angeles only spent about \$2 million in construction costs and used a more significant portion of funding to purchase charger hardware itself. These projects illustrate how vehicle duty cycles and site-specific needs drastically affect charging

---

<sup>107</sup> California Air Resources Board staff. 2019. *EV Charging Infrastructure: Nonresidential Building Standards*. California Air Resources Board.



infrastructure costs, and that costs can vary widely even when the environment or goals appear similar. Policy makers must recognize that while a charger deployment may meet the energy needs of select medium- and heavy-duty vehicles, meeting the broad needs of all fleets statewide requires a diverse range of chargers capable of accommodating different power levels, geometries, and duty cycles. Recognizing this fact, in July 2020 the CEC announced \$3 million in funding to help entities in California develop blueprints that identify needs, actions, and milestones for medium- and heavy-duty charging infrastructure deployment.<sup>108</sup>

Medium- and heavy-duty vehicles, being more massive than the light-duty counterparts, generally use more energy to operate and require higher charging power. Power levels to charge these vehicles may reach several megawatts, introducing significant challenges to local distribution grids and to vehicle operators who face costly facility upgrades. For comparison, charging one heavy-duty vehicle at 2 MW uses as much power as simultaneously fast-charging 10-20 light-duty vehicles. A preliminary analysis using the CEC's EDGE tool found that California's IOUs should proactively plan to accommodate MD/HD fleets, including through grid upgrades or other mitigative action.<sup>109</sup> This finding indicates that charger deployments for larger vehicles may frequently require new utility grid hardware in addition to the charger itself. Furthermore, in some off-road applications such as construction or agriculture, access to the grid may be nonexistent.

Even if additional electrical capacity is available from the grid and at the facility, charger site hosts or vehicle operators can face costly demand charges based on peak power demand depending on the utility rate structure. Some sites can install distributed energy resources (including local generation and stationary storage) to limit facility peak demand and enable charging power levels that would otherwise be too costly or require grid upgrades. Where operational requirements allow, smart charging and other managed charging strategies can help limit instantaneous power demand and minimize long-term charging expenses.<sup>110</sup> The

---

108 CEC. "[GFO-20-601 — Blueprints for Medium- and Heavy-Duty Zero-Emission Vehicle Infrastructure.](https://www.energy.ca.gov/solicitations/2020-07/gfo-20-601-blueprints-medium-and-heavy-duty-zero-emission-vehicle)" <https://www.energy.ca.gov/solicitations/2020-07/gfo-20-601-blueprints-medium-and-heavy-duty-zero-emission-vehicle>.

109 Publicly Owned Utilities should also proactively plan for high powered charging deployments, but capacity maps for POUs are unavailable online and have not yet been incorporated into EDGE.

110 Santa Clara Valley Transportation Authority. July 9, 2019. "[VTA Supports the LACI Feedback for Managed Electrified Fleet Charging Especially for Transit Bus Fleets.](https://efiling.energy.ca.gov/GetDocument.aspx?tn=228926)" <https://efiling.energy.ca.gov/GetDocument.aspx?tn=228926>.

CEC is funding research and demonstration projects in these areas through solicitations under the Electric Program Investment Charge (EPIC)<sup>111</sup> and Clean Transportation Program.<sup>112</sup>

As discussed earlier, charger interoperability is a potent concern among early adopters of electrified medium- and heavy-duty vehicles and equipment, particularly in cargo-handling environments where multiple equipment types from numerous manufacturers are present. Some manufacturers repurpose connectors originally designed for the light-duty segment, while others often use proprietary connectors incompatible with other vehicles or equipment types. At a May 2020 workshop, BNSF noted that some of its chargers were not interoperable even among vehicle models from the same manufacturer.<sup>113</sup> On the other hand, as electrification of the medium- and heavy-duty sector continues, power transfer will likely expand to methods beyond conductive connectors. While charging with a plug may remain the default choice, some vehicles may automate plug-based charging or include other methods such as wireless charging or automated pantograph charging<sup>114</sup> for certain use cases. Regardless of the power transfer method of the charger, CEC should prioritize interoperable implementations that conform to existing and in-development standards from CharIN<sup>115</sup> and the Society of Automotive Engineers.

Landlord-tenant relationships further complicate medium- and heavy-duty vehicle charging infrastructure planning. Infrastructure may be supplied by a different party than the vehicle or equipment operator. This is often the case at California's seaports and airports, where private terminal operators own and operate equipment but are usually not responsible for major site improvements such as electrical infrastructure. Such relationships may complicate financial responsibility and require greater coordination for infrastructure deployment, but these challenges are not insurmountable. The Port of Long Beach's EV Blueprint, for example, outlines steps encouraging collaboration between the port and terminal operators for new

---

111 CEC. "[GFO-20-304 — Evaluating Bi-Directional Energy Transfers and Distributed Energy Resource Integration for Medium- and Heavy-Duty Fleet Electrification.](https://www.energy.ca.gov/solicitations/2020-09/gfo-20-304-evaluating-bi-directional-energy-transfers-and-distributed-energy)" <https://www.energy.ca.gov/solicitations/2020-09/gfo-20-304-evaluating-bi-directional-energy-transfers-and-distributed-energy>.

112 CEC. "[GFO-20-605 — BESTFIT Innovative Charging Solutions.](https://www.energy.ca.gov/solicitations/2020-08/gfo-20-605-bestfit-innovative-charging-solutions)" <https://www.energy.ca.gov/solicitations/2020-08/gfo-20-605-bestfit-innovative-charging-solutions>.

113 Comments by Amanda Marruffo (BNSF) at Integrated Energy Policy Report Commissioner Workshop on Heavy-Duty Zero-Emission Vehicle Market Trends on May 20, 2020.

114 Pantograph charging uses as a moveable arm to connect charging conductors on top of a vehicle to an overhead charger. These are visually similar to the overhead catenary system found on many light rail systems.

115 The CEC is partly funding the development of CharIN's Megawatt Charging System (formerly High Power Charging for Commercial Vehicles) connector standard under [contract 600-15-001](#).



equipment and charging infrastructure deployment. As part of its effort to involve operators in infrastructure preparation, the port has developed an energy forecasting tool to help operators estimate the power and energy demands given their existing equipment duty cycles. The CEC should encourage developing similar tools and partnerships and ensure that any funding or program requirements accommodate landlord-tenant and other multiparty ownership schemes. Further, clear state policy and regulations can provide strong signals to encourage all stakeholders at a given site to work collaboratively towards a common outcome.

## **Continue Streamlining Local Permitting Ordinances**

As with most types of construction, charging infrastructure installation must comply with local building, safety, and permitting regulations. In response to complaints that existing permitting processes were cumbersome and inconsistent across municipalities, in 2015 the Legislature passed AB 1236, which required cities and counties to simplify permitting for charger installations. The bill required local governments to adopt ordinances streamlining and clarifying charger permitting and prohibited unreasonable barriers to installation, such as aesthetic reviews. While AB 1236 set a compliance deadline of September 2017, only half of the 540 jurisdictions tracked by the Governor’s Office of Business and Economic Development (GO-Biz) had streamlined or were streamlining charger permitting ordinances as of October 2020. Of the jurisdictions tracked, 269 had no streamlining efforts.<sup>116</sup>

Electric vehicle service providers have continued raising concerns that AB 1236 noncompliance presents a significant hurdle for charger deployment. During a June 2020 presentation, Electrify America indicated that its California projects cost 24 percent more and took 59 percent longer than the national average, and that soft costs such as permitting remain major challenges in the state.<sup>117</sup> Burdensome permitting processes needlessly delay charger installation and pose a barrier to California’s charger deployment goals. GO-Biz has assembled resources, such as example ordinances and a permitting guidebook, and tracks AB 1236 progress across California using an eight-part scorecard. CEC should continue supporting GO-Biz’s efforts to achieve statewide AB 1236 compliance.

---

116 California Governor’s Office of Business and Economic Development (GO-Biz) staff. 2020. “[Plug-in Electric Vehicle Charging Station Readiness](https://business.ca.gov/industries/zero-emission-vehicles/plug-in-readiness/).” <https://business.ca.gov/industries/zero-emission-vehicles/plug-in-readiness/>.

117 Nelson, Matthew. 2020. “[Presentation — Electrify America](https://efiling.energy.ca.gov/GetDocument.aspx?tn=233622&DocumentContentId=66202).” <https://efiling.energy.ca.gov/GetDocument.aspx?tn=233622&DocumentContentId=66202>.

## Publicly Owned Utilities Should Continue to Enhance Their Preparedness for Electrification

California's POUs, which are generally smaller than its IOUs, are well-positioned to assess their unique regional grid operations and establish charging infrastructure strategies addressing their local needs and statewide goals. Following Public Utilities Code Sections 9621 and 9622, POUs with annual electrical demand exceeding 700 gigawatt-hours are required to adopt integrated resource plans that address transportation electrification, and to submit these plans to the CEC.<sup>118</sup> A recent CEC staff review of these plans<sup>119</sup> found that many POUs were developing investment and outreach programs to promote PEV adoption, and several had existing or anticipated charger incentive programs. Several POUs also highlighted aspects of their investment plans that aligned with air pollution and ZEV goals, and some discussed the impact of transportation electrification on disadvantaged communities.

However, the integrated resource plans could be improved with regards to transportation electrification program planning. For example, the guidelines encouraged utilities to describe efforts to coordinate preparations for transportation electrification with neighboring utilities.<sup>120</sup> However, only three of the sixteen (Burbank, Anaheim, and Los Angeles Department of Water and Power) utilities discussed their efforts to harmonize programs and initiatives.<sup>121</sup> Improving this coordination may prove important to supporting driver-friendly charging network development. Furthermore, while many POUs acknowledged that transportation electrification would increase overall electricity consumption, most did not discuss the costs or operational impacts of this added load in their plans. Given that PEV adoption is growing across California, POUs should seek to sharpen their analysis of and preparedness for the impacts of increased electricity demand from vehicle charging. Integrated resource plans should discuss the charging load impacts in greater detail and identify possible grid upgrade needs in POU

---

118 Vidaver, David, Melissa Jones, Paul Deaver, and Robert Kennedy. 2018. *Publicly Owned Utility Integrated Resource Plan Submission and Review Guidelines – Revised Second Edition*. California Energy Commission. Publication Number: CEC-200-2018-004- CMF. <https://efiling.energy.ca.gov/GetDocument.aspx?tn=224889&DocumentContentId=55481>.

119 Available in docket log for [18-IRP-01](https://efiling.energy.ca.gov/Lists/DocketLog.aspx?docketnumber=18-IRP-01) <https://efiling.energy.ca.gov/Lists/DocketLog.aspx?docketnumber=18-IRP-01>.

<sup>120</sup> For example, the POU IRP Submission and Review Guidelines at 10 included:  
"7. Plans to coordinate with adjacent or similarly situated utilities to meet broader community or regional infrastructure needs and ensure harmonious inter-territory operations of electric transportation technologies."

<sup>121</sup> Both Anaheim and LADWP reports mention active coordination with other POUs via the EV Working Group of the Southern California Public Power Authority (SCPPA) while Burbank's report states working within LADWP's balancing authority.

territory and neighboring regions. POU's should work with the CEC to incorporate their data into the CEC's modeling efforts, including the EDGE tool. This incorporation will help identify strategies to minimize or mitigate grid impacts in and across service territories.

## **Develop Workforce to Support Charging Infrastructure Deployment**

California's PEV charger supply chain is an emerging industry. In-state manufacturers have cultivated supply chain partners to meet domestic and global demand for their charging products. About 14,100 Californians are employed across 34 ZEV-related companies.<sup>122</sup> The state has contributed to the development of these companies and technologies through policies, investments, and fleet preferences.<sup>123</sup> California's charger incentive programs<sup>124</sup> use funding to accelerate charger installations across the state. These funding programs have relied, in part, on the availability of a workforce with key occupational skillsets, including utility make-ready designs, construction, and charging infrastructure maintenance. Figure 23 identifies the sequence of project milestone activities and occupations. Workforce training and development to date have occurred through a mix of employer on-the-job training and institutions such as the CEC's Clean Transportation Program, California community colleges, other state entities, regional workforce investment boards, the Electric Vehicle Infrastructure Training Program, and the California Transit Training Consortium, to name a few.

---

122 Based on CEC staff research.

123 Examples include CAEATFA Sales and Use Tax Exclusion, Clean Transportation Program funding, and the California Competes Tax Credit.

124 Examples include CALeVIP, Electrify America, and CPUC's Senate Bill 350 Transportation Electrification Programs.

**Figure 23: Key Occupations for Electric Vehicle Charging Infrastructure**

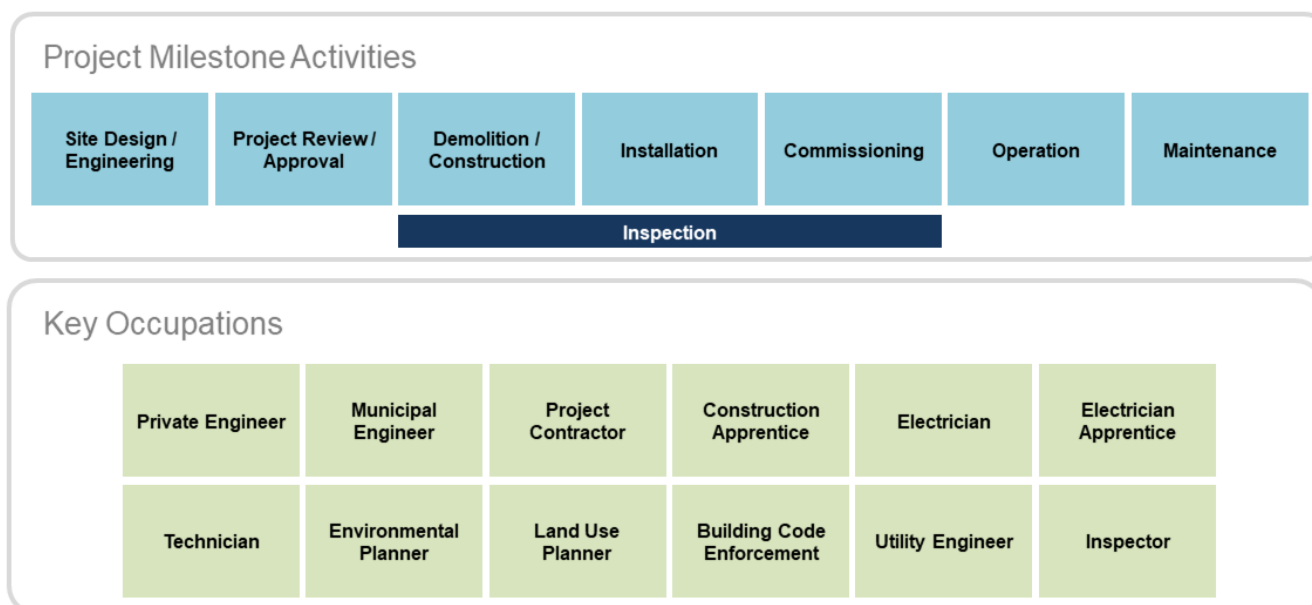

Source: CEC

Several state agencies are engaged in ensuring that a robust workforce is prepared to support ZEV infrastructure deployment. In December 2018, the CPUC issued an order instituting rulemaking to continue the development of rates and infrastructure for vehicle electrification (DRIVE OIR 18-12-006).<sup>125</sup> The rulemaking continues the implementation and administration of transportation electrification programs, tariffs, and policies at the CPUC and “seeks to develop a comprehensive framework to guide the CPUC’s role in the electrification of California’s transportation sector.” CPUC’s Draft Transportation Electrification Framework seeks to address equity — the disproportionate burden of air quality and climate change impacts — and widespread transportation electrification, including workforce training and development. The framework notes IOUs should consider whether any incremental workforce training is needed to support the scale of transportation electrification infrastructure installation expected in their transportation electrification plans.

In July 2020, the CEC held a public workshop to discuss the potential training and certification requirements for inclusion in CALeVIP. At the workshop, the Contractors State Licensing Board provided an overview of California Labor Code Section 108.2, for certification of electricians, that specifies that “certification is required only for those persons who perform work as

---

125 CPUC staff. 2018. [R1812006 Development of Rates and Infrastructure for Vehicle Electrification](https://docs.cpuc.ca.gov/SearchRes.aspx?DocFormat=ALL&DocID=252025566).  
<https://docs.cpuc.ca.gov/SearchRes.aspx?DocFormat=ALL&DocID=252025566>.

electricians for contractors licensed as Class C-10 electrical licensed contractors under the Contractors' State License Board rules and regulations." The Contractors State Licensing Board also articulated that the average number of C-10 license holders each year is approximately 24,500. Stakeholder comments during the workshop and in the docket<sup>126</sup> expressed agreement with the safety imperative for EVSE installation and operations, the value of certified electricians with specific EVSE installation knowledge, and the need to better understand workforce projections needed to meet the states ZEV infrastructure goals through 2025 and beyond.

CARB has identified a suite of mobile source zero-emission measures<sup>127</sup> designed to help meet the state's air quality goals, including the Innovative Clean Transit Rule, the Advanced Clean Trucks regulation, the Transportation Refrigeration Units regulation, and the Cargo Handling Equipment regulation. As part of assessing charging infrastructure needs, the CEC will continue to assess the requisite infrastructure for these ZEV deployments and related workforce impacts. CARB has also articulated a plan to embed equity and engagement in accompanying implementation of their measures. Disadvantaged and low-income communities can accrue environmental and economic benefits, including the creation of good jobs, if inclusion is intentional starting with workforce training, support for career pathways, and resource alignment. As these measures receive CARB approval, it will be important to assess and monitor workforce issues associated with implementation and scale for all on- and off-road electric transportation infrastructure.

The California ZEV and ZEV infrastructure supply chain, as an emerging industry, constantly reassesses suppliers, workforce needs, and market demand for products not only in California, but nationally and globally as well. ZEV and ZEV infrastructure companies are driven to innovate technologies and grow to scale in response to CARB regulations and California's demand for these products and services. The state should evaluate the workforce needs for EV infrastructure in terms of workload capacity, training and certification, job quality, and regional differences. Given that Figure 23 above shows occupations whose scope extends beyond charging infrastructure, the state should also evaluate this workforce for applications beyond charging infrastructure that are relevant to implementing the above suite of aggressive zero-emissions measures.

---

126 CEC. "[Block Grant for Electric Vehicle Charger Incentive Projects.](https://efiling.energy.ca.gov/Lists/DocketLog.aspx?docketnumber=17-EVI-01)" Docket 17-EVI-01. <https://efiling.energy.ca.gov/Lists/DocketLog.aspx?docketnumber=17-EVI-01>.

127 CARB. March 25, 2020. "[2020 Mobile Source Strategy: A Vision for Clean Air.](https://ww3.arb.ca.gov/planning/sip/2020mss/pres_marwbnr.pdf)" Public Webinar. [https://ww3.arb.ca.gov/planning/sip/2020mss/pres\\_marwbnr.pdf](https://ww3.arb.ca.gov/planning/sip/2020mss/pres_marwbnr.pdf).

# CHAPTER 7:

## Financing California's Charging Infrastructure Needs

---

In the long-term, the electric vehicle and charger markets will need to be self-sustaining. While PEVs are projected to reach cost-parity with internal combustion vehicles in the next few years, there is more uncertainty about the charging market's path to self-sufficiency. Electricity sales alone may not be enough to maintain sustainable business operations or cover capital costs for planning and constructing charging infrastructure. Continued deployment incentives and innovation-enabling policies are critical to promoting private investment and a sustainable industry.

### **Continued Public Support for Charger Deployment is Essential to Meet State ZEV Goals**

Deploying the charging infrastructure needed to support California's ZEV adoption, decarbonization, and air quality goals will require clear planning and fast deployment of accessible financing to help the charging industry scale up. The CEC has led on both fronts for the State through the quantitative and qualitative planning analyses described in this report, and through its Clean Transportation Program which invests up to \$100 million annually in a broad portfolio of transportation and fuel-related projects throughout the state. Since the program's inception in 2009, the state has invested nearly \$899 million in key projects across the State. Around 36 percent of the program's project funds were awarded to projects within disadvantaged or low-income communities or both. When excluding statewide projects or those without an applicable site, this funding share is closer to 50 percent<sup>128</sup>.

California's network of roughly 67,000 public and shared private chargers has been supported by state programs, ratepayer funds, and settlement agreements. The Energy Commission's Clean Transportation Program has invested \$194 million in public and shared private light duty vehicle charging infrastructure over the past 13 years.

The California Electric Vehicle Infrastructure Project (CALeVIP) is the CEC's flagship incentive program for light-duty charging infrastructure. CALeVIP uses the EVI-Pro tool described in Chapter 4 to estimate where local and regional gaps in charger deployment exist,

---

<sup>128</sup> California Energy Commission staff. 2020. *2020-2023 Investment Plan Update for the Clean Transportation Program*. California Energy Commission. Publication Number: CEC-600-2020-003

and CALeVIP then targets funding to address those gaps.<sup>129</sup> As of November 2020, CALeVIP has launched eight regional incentive projects totaling \$95.4 million in rebate funding, potentially deploying 4,800 Level 2 connectors and 720 DC fast chargers. Illustrating the immense popularity of the program, CALeVIP incentives are oversubscribed by \$207 million, representing roughly 4,100 Level 2 connectors and 2,700 DC fast chargers. Most of the CALeVIP incentive projects are required to invest at least 25 percent of available rebates for disadvantaged or low-income communities or a combination, with many of the projects achieving upward of 35-50 percent.

Preliminary data from a subset of projects completed through August 31, 2020, show that CALeVIP provides an average rebate of \$536/kW for Level 2 connectors and \$1,300/kW for DC fast chargers. Notably, this investment is leveraged with additional funds from the project developer and customer to complete the projects with an average total cost of \$1,350/kW for Level 2 connectors and \$2,007/kW for DC fast chargers — representing a match of 60 percent and 35 percent, respectively.<sup>130</sup>

The CALeVIP design specifically incorporates flexibility within the approaches to asset ownership and charging business models (by supporting a variety of site types), as well as to qualifying EVSPs (including 19 manufacturers of charging equipment) into the program. This flexibility has enabled the state to quickly and cost-effectively increase charger deployment in key areas that lack needed infrastructure. A key feature of the success of the project has been working closely with regional governments to enter markets upon ensuring that permitting processes have been streamlined.<sup>131</sup> The administrative simplicity of the CALeVIP platform has resulted in partner funding contributions on the order of \$10 million (as of October 31, 2020) from community choice retail energy providers, air quality management districts, and metropolitan planning organizations.<sup>132</sup> The success of CALeVIP as a model for infrastructure

---

<sup>129</sup> CALeVIP. Incentive Project Planning. <https://calevip.org/incentive-project-planning>

<sup>130</sup> Data to be published at <https://www.energy.ca.gov/programs-and-topics/programs/clean-transportation-program/california-electric-vehicle>.

<sup>131</sup> August 30, 2019 CALeVIP Permitting Workshop presentations from the Energy Commission ([Clean Transportation Program](#)), GO-Biz ([Electric Vehicle Charging Station Permitting Guidebook](#)) and Division of the State Architect ([Electric Vehicle Charging Stations](#)).

<sup>132</sup> Future projects beginning with Peninsula-Silicon Valley in December 2020 will include more than \$30 million in partner funds.

program design is illustrated by efforts to emulate the implementation in New York<sup>133</sup> and ongoing discussion on project design with counterpart staff that are developing initiatives in three other states.

## **Mandates and Infrastructure Incentives have Driven Charging Infrastructure Growth**

Executive orders and legislation have established California's interest in economic growth supported by the charging and ZEV industries. Executive Order B-16-2012 ordered state agencies to establish benchmarks to help grow private sector investment in ZEV infrastructure by 2015 and targeted a strong and sustainable ZEV industry as part of California's economy by 2025.<sup>134</sup> In 2015, Senate Bill 350 (De León, Chapter 547, Statutes of 2015) expanded the roles of electric utilities in supporting transportation electrification, and the Legislature declared that "electrification should stimulate innovation and competition, enable consumer options in charging equipment and services, attract private capital investments, and create high-quality jobs for Californians, where technologically feasible."<sup>135</sup> Specifically, SB 350 stated that utility transportation electrification programs should not unfairly compete with nonutility enterprises.<sup>136</sup>

A critical enabler of early-stage charging infrastructure growth has been the CPUC's decisions<sup>137</sup> concluding that charging service providers are not classified as public utilities, in accordance with the Legislature's intentions to encourage the development of business models for transportation electrification. While companies have demonstrated success in deploying charging solutions requiring little or no ratepayer or public funding support, at present, many charging service providers have not found a self-sustaining business model operable at the scale for California to achieve widespread electrification.

---

133 New York State Energy Research and Development Authority. "[Charge Ready NY](https://www.nyserda.ny.gov/All-Programs/Programs/ChargeNY/Charge-Electric/Charging-Station-Programs/Charge-Ready-NY)." <https://www.nyserda.ny.gov/All-Programs/Programs/ChargeNY/Charge-Electric/Charging-Station-Programs/Charge-Ready-NY>.

134 Governor Edmund G. Brown Jr. March 23, 2012. [Executive Order B-16-2012](https://www.ca.gov/archive/gov39/2012/03/23/news17472/index.html). <https://www.ca.gov/archive/gov39/2012/03/23/news17472/index.html>.

135 Public Utilities Code Section 740.12(b).

136 Public Utilities Code Section 740.3(c).

137 California Public Utilities Commission. Decision in Phase 1 on Whether a Corporation or Person That Sells Electric Vehicle Charging Services to the Public is a Public Utility ([D.10-07-044](#)) and Decision Clarifying Status of Electric Vehicle Charging Service Providers as Public Utilities ([D.20-09-025](#)).



Based on responses to a February 2020 request for information for “Strategies to Attract Private Investment in Zero Emission Vehicle Charging Infrastructure and Other Clean Transportation,” as well as further conversations with investors, CEC staff has identified important insights relating to a sustainable charging market.<sup>138</sup> These insights confirmed that vehicle mandates and infrastructure incentives have driven early opportunities for growth in charging infrastructure. Listed below are supporting regulations that have seeded growth for the nascent charging infrastructure market.

- The CPUC’s decisions to not regulate charging service providers as utilities, described previously, have enabled the market to introduce a broad range of business models that independently deliver electricity as a fuel.<sup>139</sup> These decisions have been foundational in driving competition, market experimentation, and private investment in charging services.
- Incentives funded by utilities,<sup>140</sup> state programs,<sup>141</sup> and settlement funds<sup>142</sup> have helped reduce cost barriers to charger installation. These programs have been necessary to support the market. However, these funding sources alone cannot support the long-term market transformation that is required to meet state goals. Further, these funds are limited. Companies investing in charging projects highlighted that uncertainty regarding the availability of future funds jeopardizes the ability to plan deployments effectively.

---

138 Comments and subsequent discussion with stakeholders participating in Docket No. [20-FINANCE-01](#), Strategies to Attract Private Investment In Zero Emission Vehicle Charging Infrastructure and Other Clean Transportation Projects <https://efiling.energy.ca.gov/Lists/DocketLog.aspx?docketnumber=20-FINANCE-01>.

139 Specifically, D.10-07-044 determined that charging services for light-duty vehicles are not subject to regulation as utility, and D.20-09-025 clarified that this exemption also includes charging services for MD/HD vehicles.

140 CPUC. 2020. “[Transportation Electrification Activities Pursuant to Senate Bill 350](#).” <https://www.cpuc.ca.gov/sb350te/>.

141 Such as the CEC’s [Clean Transportation Program](#). More information is available at <https://www.energy.ca.gov/programs-and-topics/programs/clean-transportation-program>.

142 In 2012 and 2015, California negotiated legal agreements with NRG and Volkswagen to install charging infrastructure to settle harms resulting from the 2001 electricity crisis and excessive diesel combustion emissions from Volkswagen vehicles, respectively.

- The Low Carbon Fuel Standard,<sup>143</sup> which offers a combination of capacity credits, base fuel credits, and incremental fuel credits, created greater financial certainty for new charger deployments and encouraged the delivery of electricity as a fuel. The regulation provides capacity credits for new fast-charger deployments,<sup>144</sup> base credits for delivery of electricity as a fuel, and incremental credits to encourage smart charging.<sup>145</sup>
- State and local building codes have encouraged or required the installation of charger make-ready equipment. The 2016 Green Building Standards (CALGreen) Code, Title 24, Part 11,<sup>146</sup> requires builders to provide capacity for electric vehicle charging for many types of new construction, thus avoiding the substantial infrastructure costs that would otherwise be incurred as major retrofits. Building codes are an important tool in cost-effectively ensuring the state meets its zero-emission vehicles goals; they may prove essential in order to support residents of multi-unit dwellings. They must keep pace to ensure broad access to ZEV infrastructure.
- In 2018, updates to the SB 375 GHG Emissions Reduction Targets introduced greater regulatory flexibility and included charging infrastructure as a compliance pathway for Sustainable Communities Strategies.<sup>147</sup> Metropolitan planning organizations can invest in regional charging infrastructure beyond existing and future state programs as a transportation measure within their Sustainable Communities Strategies.

In the longer term, market-based expansion will rely on regulatory certainty and flexibility afforded by the state's transportation and emissions reduction policies.

California is home to 34 ZEV-related companies (including ZEV manufacturers, ZEV components, and ZEV infrastructure) with an estimated market capitalization of more than

---

143 CARB. 2020. [Low Carbon Fuel Standard Regulation](https://ww2.arb.ca.gov/sites/default/files/2020-07/2020_lcfs_fro_oal-approved_unofficial_06302020.pdf). [https://ww2.arb.ca.gov/sites/default/files/2020-07/2020\\_lcfs\\_fro\\_oal-approved\\_unofficial\\_06302020.pdf](https://ww2.arb.ca.gov/sites/default/files/2020-07/2020_lcfs_fro_oal-approved_unofficial_06302020.pdf).

144 Section 95486.2 of the regulation describes capacity credits for new fast charger deployments, which decrease as utilization of the charger increases.

145 Section 95486.1 describes credits for fuel delivery, including incremental credits that encourage smart charging when electricity carbon intensity is low.

146 [2016 California Green Building Standards Code](https://codes.iccsafe.org/content/CAGBSC2016S0819PA/chapter-4-residential-mandatory-measures), Part 11, Chapter 4 Residential Mandatory Measures, Section 4.106.4.1, 4.106.4.2, and 4.106.4.3. <https://codes.iccsafe.org/content/CAGBSC2016S0819PA/chapter-4-residential-mandatory-measures>.

147 CARB. 2018. [Proposed Update to the SB 375 GHG Emissions Reduction Targets](https://ww3.arb.ca.gov/cc/sb375/sb375_target_update_final_ea.pdf). [https://ww3.arb.ca.gov/cc/sb375/sb375\\_target\\_update\\_final\\_ea.pdf](https://ww3.arb.ca.gov/cc/sb375/sb375_target_update_final_ea.pdf).

\$500 billion.<sup>148</sup> An assessment conducted for the U.S. Department of Energy concluded that California’s light-duty charging infrastructure supply chain represented more than one-third of the U.S. market. The assessment emphasized that charging has high vitality, has numerous players, and is meeting current market needs but should improve “the design thinking around technology” to accelerate the market and overcome business model challenges.<sup>149</sup> The EV charging industry utilizes a variety of business models. Many companies are leveraging advanced technology and consumer-oriented designs around chargers to address the issues stemming from constrained electrical capacity and highly valuable real estate.

This interest in innovation was further demonstrated in a \$7.5 million funding solicitation issued by the CEC in November 2020, wherein 45 teams of companies bid 55 unique projects to demonstrate new charging applications that reduce costs, advance the customer experience, and improve the utilization of infrastructure for all sectors of on-road vehicles.<sup>150</sup> The passing proposals represent a demand for Clean Transportation Program investments on the order of \$60 million dollars, and emphasize the importance of the state pursuing transformative charging infrastructure technologies in partnership with private sector entrepreneurs.

Highlighted in Figure 24, Figure 25, and Figure 26 are examples of EV service providers that are innovating their charging services to expand the locations where charging can be installed cost-effectively.

---

<sup>148</sup> Market capitalization of ZEV manufacturers and related entities, as of December 2020.

<sup>149</sup> Market share represented as the number of EVSE supply chain companies with headquarters in the United States in Figure 3. Synthesis Partners. 2020. [North American \(NA\) Light-duty Electric Vehicle \(LDEV\) Supplier Equipment Market and Supply Chain Gap Intelligence](https://synthesispartners.files.wordpress.com/2020/06/naldev-evse-supply-chain-assessment-and-gap-intelligence-final-public-report-issued-april-2020.pdf). <https://synthesispartners.files.wordpress.com/2020/06/naldev-evse-supply-chain-assessment-and-gap-intelligence-final-public-report-issued-april-2020.pdf>.

<sup>150</sup> CEC. [GFO-20-605 - BESTFIT Innovative Charging Solutions](https://www.energy.ca.gov/sites/default/files/2020-11/GFO-20-605%20NOPAR_ADA.docx). [https://www.energy.ca.gov/sites/default/files/2020-11/GFO-20-605%20NOPAR\\_ADA.docx](https://www.energy.ca.gov/sites/default/files/2020-11/GFO-20-605%20NOPAR_ADA.docx).

**Figure 24: Charging “Beyond the Grid”**



San Leandro-based FreeWire Technologies integrates lithium-ion batteries into small-footprint chargers to provide charging solutions with minimal grid impact. The Mobi charger, a mobile charging unit with a built-in 80 kWh battery, can move around a parking area to charge up to 10 vehicles per day at up to 11 kW. Customers can charge the Mobi overnight in preparation for the next day’s charging needs, avoiding peak demand. The Mobi offers a quick, low-impact solution for charging multiple vehicles without the need for extensive permitting, engineering, construction, and parking displacement. The stationary Boost Charger, shown here with internal components, is a 120 kW DC fast charger with a built-in 160 kWh battery. The onboard battery enables DC fast charging from lower-voltage inputs (208-240 volts alternating current [VAC]) from the facility and eliminates the need for costly and bulky make-ready equipment typical of most DC fast charger deployments.

Photo: FreeWire Technologies

**Figure 25: Serving a Broader Driver Market**

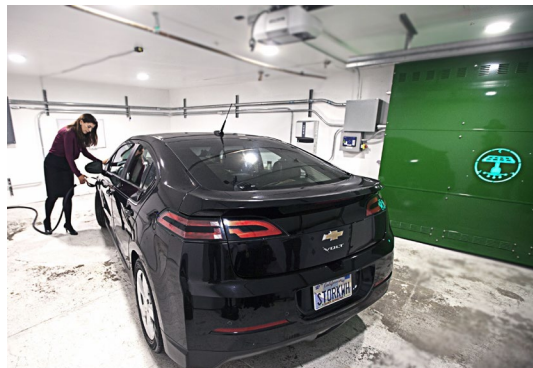

San Francisco-based Powertree Services offers monthly subscriptions to chargers installed at multiunit dwellings that serve tenants *and* nearby residents. Powertree works with apartment owners and developers to build charging stations supported by photovoltaics, battery storage, and an energy management system that together minimize or eliminate the need for transformer or service upgrades. Powertree overcomes low initial charger use, the cost of “lost” parking spaces, and the uncertainty of tenant turnover by allowing residents and neighbors to share access to a single charger for all vehicle types and a system that provides clean electricity and backup power during emergencies, creating a valuable asset for the building owner.

Photo: Powertree

**Figure 26: Challenging the Premise That Networks Must “Charge for Charging”**

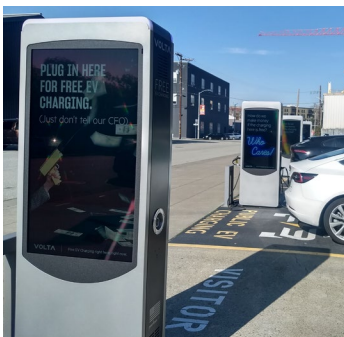

**San Francisco-based Volta Charging installs and operates a network of free public chargers located chiefly near the entrances of anchor tenants of commercial retail centers. Prominent placement maximizes charger usage and improves confidence among prospective PEV users in the community, and the large displays show messages from tenants or third-party sponsors. Charging as an amenity helps retailers attract and retain visitors, a feature that can be more valuable than the cost of the installation or electricity. More than 90 percent of Volta’s nearly 200 stations in California are small, having four or fewer Level 2 chargers, limiting the need for immediate grid upgrades. Volta is also expanding its network to include 50 kW DC fast chargers with load management.**

Photo: CEC staff

Notably, the preceding examples of innovative charging solutions (FreeWire Technologies, Powertree Services, and Volta Charging) are attracting private capital to scale deployment with limited Clean Transportation Program demonstration<sup>151</sup> and manufacturing<sup>152</sup> grants. These entities and their competitors are trying to grow and serve more infrastructure while adapting to industry dynamics, regulatory directives, and consumer uncertainty. However, as new markets open and demand their services, new challenges arise that can limit growth.

## **Promoting Private Investment Will Lead to Self-Sustaining Industry**

Facilitating a conducive policy and financial environment for charging infrastructure is critical to realizing the transformation to carbon neutrality by 2045. Success will be contingent upon

---

151 California Energy Commission Agreement ARV-13-057 with Powertree Services, for \$500,000.

152 California Energy Commission Agreement ARV-19-072 with Freewire Technologies, Inc. for \$1.98 million.

the expansion of existing and the certain deployment of new incentives, especially in the near- and mid-term. With continued planning, through efforts like those described in AB 2127, and public financing, through funding initiatives like the Clean Transportation Program, the State can accelerate progress towards achieving California’s ZEV goals until sustainable business models are feasible and widespread in the charging industry.

Following the AB 2127 directive to “consider all necessary charging infrastructure” and “programs to accelerate the adoption of electric vehicles,” the CEC identified several factors as critical to spurring self-sustaining growth.<sup>153</sup> Successful private investment in charging infrastructure could be promoted by several conditions:

### **1. Coordinated Government and Regulatory Actions Supporting the Need for 100 Percent ZEVs**

Reaching 100 percent ZEV market outcomes will require sending clear market signals to market participants and investors. Public agency modeling activities to understand technical needs and geographic gaps in charging through a stakeholder process will help support and direct the market. Further, programs and funding to encourage solutions tailored to local needs that reduce the total cost of operations, will enable EVSPs to better serve harder-to-reach customer segments that face financial or grid constraints. The public may need to invest to solve industrywide constraints, particularly in areas such as interoperability<sup>154</sup> and functional testing capacity,<sup>155</sup> so that first-mover companies do not have to bear disproportionate startup costs. Investments that enable growth among multiple equipment manufacturers or EVSPs in the state and beyond can confirm to investors that the opportunity extends to a broader

---

<sup>153</sup> Comments and subsequent discussion with stakeholders participating in Docket No. [20-FINANCE-01](https://efiling.energy.ca.gov/Lists/DocketLog.aspx?docketnumber=20-FINANCE-01), Strategies to Attract Private Investment In Zero Emission Vehicle Charging Infrastructure and Other Clean Transportation Projects <https://efiling.energy.ca.gov/Lists/DocketLog.aspx?docketnumber=20-FINANCE-01>.

<sup>154</sup> For example, the California Energy Commission recently amended an existing technical support contract to perform functional evaluations of charging systems to support interoperability for MD/HD vehicles. [Agreement 600-15-001, amendment 4 with National Renewable Energy Laboratory](https://ww2.energy.ca.gov/business_meetings/2020_packets/2020-04-08/Item_01c_600-15-001-04%20DOE%20National%20Renewable%20Energy%20Laboratory_ADA.pdf). More information is available at [https://ww2.energy.ca.gov/business\\_meetings/2020\\_packets/2020-04-08/Item\\_01c\\_600-15-001-04%20DOE%20National%20Renewable%20Energy%20Laboratory\\_ADA.pdf](https://ww2.energy.ca.gov/business_meetings/2020_packets/2020-04-08/Item_01c_600-15-001-04%20DOE%20National%20Renewable%20Energy%20Laboratory_ADA.pdf).

<sup>155</sup> Several charging equipment providers including EVBox, Freewire, Hubject, ChargePoint, Siemens, EnelX, Greenlots, Electrify America, IoTecha, Nuvve, Flo, and those represented by CharIN and EV Charging Association responded to the [November 11, 2019 workshop](https://www.energy.ca.gov/event/workshop/2020-05/staff-solicitation-scoping-workshop-pre-solicitation-concept-vehicle-grid) in docket [17-EVI-01](https://www.energy.ca.gov/event/workshop/2020-05/staff-solicitation-scoping-workshop-pre-solicitation-concept-vehicle-grid), describing the cost, time, and technical challenges with equipment certification. CEC. “[Staff Solicitation Scoping Workshop — Pre-Solicitation Concept for Vehicle-Grid Innovation Lab \(ViGIL\)](https://www.energy.ca.gov/event/workshop/2020-05/staff-solicitation-scoping-workshop-pre-solicitation-concept-vehicle-grid).” <https://www.energy.ca.gov/event/workshop/2020-05/staff-solicitation-scoping-workshop-pre-solicitation-concept-vehicle-grid>.

achievement of nationwide<sup>156</sup> and global ZEV targets<sup>157</sup> beyond a niche in the California market.

## **2. Maturation of Charging Technologies and Companies to Raise Investor Confidence**

Transitioning an EVSP from start-up operations backed with initial capital, through first demonstrations with customers, to offering more commercial projects across electrification applications or geographies depends on the ability of the EVSP to raise successive rounds of funding. Investors may examine the charging company's intended role in the electrification ecosystem and analyze its potential to competitively meet the needs of their addressable market. The investor's due diligence on the company's financial statements, supply chain, and need for partners to complete projects will depend on whether the company is specialized (for example, a manufacturer of a charger component) or has broad scope (for example, operates a network of chargers). Corporate strategies within the charging industry to raise capital can include strategic investments by automotive manufacturers undertaking electrification, mergers among niche companies (for example, hardware and controls), acquisition by global electric utilities or conventional fueling providers, or formation of alliances to share technical resources. As companies grow, their ability to take risks implementing large commercial projects in new market segments could increase, permitting them to use additional mechanisms to complement public investment, including project finance, asset finance, and asset management.

## **3. Cost Transparency to Improve Construction Project Budgeting and Measure Advances in EVSE Functionality**

Comparative analysis of public and utility-funded infrastructure programs has been challenged by the lack of generally accepted principles for recording and disclosing the costs of installing infrastructure. This challenge stems from the nonstandard ways of invoicing items and tasks in bills of materials, variation in labor rates and permitting costs, site-specificity of project design, the overhead cost of delays due to issues outside the project developer's control, and varied

---

<sup>156</sup> Multi-State Zero Emission Vehicle Task Force. *Multi-State ZEV Action Plan, 2018-2021*. <https://www.nescaum.org/topics/zero-emission-vehicles/multi-state-zev-action-plan-2018-2021-accelerating-the-adoption-of-zero-emission-vehicles>

<sup>157</sup> International ZEV Alliance. The ZEV Alliance Participation Statement. <http://www.zevalliance.org/members/>



business strategies among EVSPs.<sup>158</sup> Further, restrictions and limitations on data disclosure prevent detailed analysis of cost drivers that could inform the design of new technological solutions or identify triggers for needed policy intervention. The prices of EVSE are readily available when sold at retail and can help illustrate the order of magnitude of savings from economies of scale. Importantly, as EVSEs rapidly undergo enhancements in features, the related costs can be benchmarked according to functions offered over time.<sup>159</sup> Absent perfect data, market participants can create higher-level benchmarks<sup>160</sup> by which both public and, increasingly, private investors can compare the costs to provision charging services.

#### **4. Diversification of Revenue Streams That Support Financial Stability and Improve the Certainty of Returns for Investors**

Beyond the basic revenue model of marking up the retail price of electricity to sell charging, investors highlighted their intention to pursue a variety of revenue streams to diversify their business. A (non-exhaustive) selection of additional revenue opportunities from charging include 1) aggregating charging to provide a grid asset that system operators can manage<sup>161</sup>; 2) monetizing emission reduction value in regulatory programs or in support of corporate sustainability policies; 3) facilitating financial benefits to the site host, such as increasing employee retention or attracting additional sales at a retail location; and 4) enhancing asset value or minimizing compliance costs for building construction. Clarifying revenue models will be critical to determine the viability of projects, to understand the effect of policies on viability,

---

<sup>158</sup> EVgo. June 1, 2020. [Strategies to Attract Private Investment in Zero Emission Vehicle Charging Infrastructure and Other Clean Transportation Projects](https://efiling.energy.ca.gov/GetDocument.aspx?tn=233276&DocumentContentId=65762).

<https://efiling.energy.ca.gov/GetDocument.aspx?tn=233276&DocumentContentId=65762> and CA Governor's Office of Business and Economic Development. June 1 2020. "Strategies to Attract Private Investment in Zero Emission Vehicle Charging Infrastructure and Other Clean Transportation Projects."

<https://efiling.energy.ca.gov/GetDocument.aspx?tn=233255&DocumentContentId=65739>

<sup>159</sup> Crisostomo, Noel. California Energy Commission. "Electric Vehicle Charging Load," 19-OIR-01 Load Management Rulemaking January 14, 2020 Workshop, Panel 3: Responding to Hourly and Sub-Hourly Grid Signals, page 5. <https://efiling.energy.ca.gov/GetDocument.aspx?tn=231541&DocumentContentId=63354>

<sup>160</sup> Comments of Patrick Kelly, EDF Renewables/Powerflex at November 19, 2019 staff workshop on CALeVIP Future Equipment Technology.

<sup>161</sup> For example, see detailed comments referenced below from Amply, Enel X, Freewire, Clean Energy Works, and Princeton Energy Systems.



and to understand the milestones at which private capital would participate.<sup>162</sup> As a starting point, the Electric Infrastructure Financial Analysis Tool (E-FAST) developed by the National Renewable Energy Laboratory for the Energy Commission can be used as a starting point for calculating breakeven electricity prices and profitability indices over time according to the EVI-Pro projection of charging behaviors.<sup>163</sup>

### **5. Enabling Liquidity of Capital and Commodity Transactions in the Long Term**

Several investors described a willingness to furnish capital to build projects if public incentives assist the project operation and increase the certainty of generating revenue in excess of operational expenses. For some EVSPs, revenue depends on the demand from drivers. Working in tandem, the prior recommendations improve liquidity and ensure that revenues sufficiently cover operational expenses. One mechanism several EVSPs pursue to improve liquidity is the use of a “shared savings” business model in which a charging company builds, operates, and sells infrastructure as a service to another company’s fleet or to a group of customers. A portion of the fleet’s or group’s cost savings from avoiding gasoline purchases and utility costs that the fleet would have incurred are shared with the EVSP.<sup>164</sup> These shared models may take the form of energy service contracts, bundling of vehicle acquisition services (such as purchases or leases), or infrastructure subscription services. These models can unlock options for multiyear supply-and-demand contracts that provide financing certainty to access mainstream financing through private equity, investment bank bond investment, publicly-traded stock company formation<sup>165</sup>, and commercial banks.

### **Exploring Innovative Programs, Financial Instruments, and Process Improvements Could Increase Private Sector Investment**

As legislation and executive orders envision, private investments should drive expansion to widespread transportation electrification in the long term. However, until the enabling

---

<sup>162</sup> CA Governor's Office of Business and Economic Development. June 1 2020. “Strategies to Attract Private Investment in Zero Emission Vehicle Charging Infrastructure and Other Clean Transportation Projects.” <https://efiling.energy.ca.gov/GetDocument.aspx?tn=233255&DocumentContentId=65739>

<sup>163</sup> Kontou, Eleftheria and Eric Wood. July 2020. *Financial Feasibility of High-Power Fast Charging Stations: Case Study in San Diego, California*. <https://efiling.energy.ca.gov/getdocument.aspx?tn=233876>.

<sup>164</sup> Amply. May 27, 2020. “Comments on Clean Transportation Financing and Investment.” <https://efiling.energy.ca.gov/GetDocument.aspx?tn=233188&DocumentContentId=65672>

<sup>165</sup> Root, Al. “Is There Enough Electricity for EVs? Yes. Here’s Who Will Charge Them,” Barrons, November 14, 2020. <https://www.barrons.com/articles/theres-enough-electricity-in-the-world-for-electric-vehicles-heres-who-will-charge-them-51605368406>

conditions described above create a sustainable approach to public-private partnerships, public investment is a critical stopgap to continue the transition, particularly in harder to reach market segments.

Stakeholder interviews raised the continued importance of vehicle and infrastructure incentives for customers and fleets. Given their experience across the variety of utility, state, and local initiatives, they highlighted how potential improvements could ease transactions to access funding and therefore complete projects while increasing funds from the private sector. Implementation of additional programs could consider the following design elements:

- **Program Navigability.** Displaying incentives for both vehicle and infrastructure in a “one-stop shop” could help applicants to identify appropriate funds from federal, state, local, and utility programs.<sup>166</sup> Consistent policy-driven and technical eligibility requirements across programs could reduce the transaction costs for EVSPs by enabling broader statewide access while improving competition.
- **Pairing Vehicles and Chargers.** Vehicle purchase incentives could be paired with a corresponding infrastructure incentive. This pairing is particularly important for cases in which the customer’s use of vehicles requires dedicated infrastructure that would not otherwise be supported by other project finance initiatives.
- **Terms of Asset Use and Operation.** Incentives should accommodate varied asset usage and business models for vehicles and infrastructure. The fleet owner may be distinct from the vehicle operators, and infrastructure host may be a separate entity from the owners of the real estate siting the infrastructure. Programs using agreeable contract terms to overcome principal-agency problems regarding physical access to a charger, or the timing of the charging, are critical.<sup>167</sup>
- **Flexible Build Timelines.** Exacting timelines for purchase or commissioning the installation may be deal breakers, particularly if the project is subject to permitting, electrical study, or utility load service constraints outside the developer’s control.<sup>168</sup> Approaches that balance milestones of project viability with flexibility to complete the project are useful especially if structural changes are needed in a region.

---

166 Comments from Volvo Group North America, May 20-21, 2020, IEPR Workshop on Heavy Duty Zero-Emission Vehicle Market Trends.

167 Powertree Services. March 28, 2020. [Observation and Recommendations for Activating Private \(Non-State\) Capital in Support of Renewable and Clean Energy Infrastructure](https://efiling.energy.ca.gov/GetDocument.aspx?tn=232575&DocumentContentId=64603).  
<https://efiling.energy.ca.gov/GetDocument.aspx?tn=232575&DocumentContentId=64603>.

168 Trillium. April 10, 2020. [Strategies to Attract Private Investment in Zero Emission Vehicle Charging Infrastructure and Other Clean Transportation Projects](https://efiling.energy.ca.gov/GetDocument.aspx?tn=232700&DocumentContentId=64761).  
<https://efiling.energy.ca.gov/GetDocument.aspx?tn=232700&DocumentContentId=64761>.

- **Market- or Performance-Based Allocation.** Investment allocations should be set with consideration of the potential for market growth to enable innovation that may not necessarily fit into existing frameworks. For example, new infrastructure providers whose approach entails customer agreements or installation designs that do not comport with existing requirements may warrant modifications to program terms to enable more participation.<sup>169</sup> In addition, serving “hard-to-reach” market segments may require increasing incentives over time, if cost reductions realized in the industry as a whole are not evenly realized across customer segments.
- **New Technology.** As electrification technologies rapidly advance, incentive programs should be structured to also consider pilot tests that promote commercial introduction. Charging technologies such as wireless or automated chargers should be funded to encourage diversity. Further commercialization could result from the positive results of a demonstration, given the potential for rapid shifts in usage as customer behaviors change and new use cases arise.

CEC initiatives may serve as forums to explore new strategies to improve customer uptake and speed deployment. These initiatives are intended to work congruently and support the simultaneous expansion of incentives needed to support widespread adoption. In coordination with program improvements being considered by the CPUC and other public funding agencies, these can promote the aforementioned market conditions to support greater private investment.

At charging infrastructure workshops in June<sup>170</sup> and August<sup>171</sup> 2020, staff presented preliminary concepts for a unified policy and economic model to accelerate widespread transportation electrification while leveraging limited public funds with private capital. This

---

169 For example, fleet equipment serving a transportation service available for use by riders of the general population is not considered “public” charging infrastructure and is ineligible from utility or publicly-administered funds, limiting the potential benefit to benefit drivers. Nadia Anderson. July 2020. “[Cruise’s Approach to Automated, Shared, and Electric Transportation.](https://efiling.energy.ca.gov/GetDocument.aspx?tn=233861&DocumentContentId=66636)”  
[https://efiling.energy.ca.gov/GetDocument.aspx?tn=233861&DocumentContentId=66636.](https://efiling.energy.ca.gov/GetDocument.aspx?tn=233861&DocumentContentId=66636)

170 Crisostomo, Noel. 2020. “[Lessons Learned From Electricity Policy for Transportation Electrification.](https://efiling.energy.ca.gov/getdocument.aspx?tn=233635)” Integrated Energy Policy Report June 24, 2020, Workshop.  
[https://efiling.energy.ca.gov/getdocument.aspx?tn=233635.](https://efiling.energy.ca.gov/getdocument.aspx?tn=233635)

171 Crisostomo, Noel. 2020. “[Assembly Bill 2127 Charging Infrastructure: Other Programs to Accelerate EV Adoption.](https://efiling.energy.ca.gov/getdocument.aspx?tn=234173)” Integrated Energy Policy Report August 4, 2020, Workshop.  
[https://efiling.energy.ca.gov/getdocument.aspx?tn=234173.](https://efiling.energy.ca.gov/getdocument.aspx?tn=234173)

concept<sup>172</sup> would create a holistic way to assess the market for charging infrastructure, invest in charging infrastructure, and deliver projects more consistently across the state.

The concept would introduce a measure of the cost to enable charging capability through the investment of public funding, which could serve as the basis for market competition for diverse charging solutions.

To maximize program effectiveness, investments could increase not only the amount of private leverage against public dollars, but other metrics. A key metric is the benefit of electric miles traveled enabled by the investment, derived from the charger power (kW), the measured or projected duration (h), and the speed of deploying the charging capability. These factors form the basis of the cost of enabled charging which could be calculated for a charging effort for a given year, shown in the Figure 27.

**Figure 27: Cost of Enabled Charging Equation**

$$\text{Cost of Enabled Charging (in } \frac{\$}{kWh} \text{)} = \frac{\text{Public Investment}}{\text{kW} * (\text{h}_{\text{measured}} + \text{h}_{\text{projected}}) * \frac{\text{Stations Installed}}{\text{Year}}}$$

Source: CEC

The cost of enabled charging is at the core of a multi-step process:

- Assess and confirm charging infrastructure-associated energy needs in a region (using tools like EVI-Pro or HEVI-LOAD) and identify locally appropriate projects (using electric vehicle ready community blueprints).
- Conduct reverse auctions to quantify the cost of charging. EVSPs bid to supply the assessed energy needs, competing with others to provide the charging services at the lowest public cost by supporting their bid with private capital (measured by the Cost of Enabled Charging).
- Budget the required public investment to supply enough charging infrastructure.
- Assign and tailor awards to EVSPs, according to their business model challenges in entering the market.
- Utilities support installations by serving agreed-upon load and offer economical rates.

Under these principles, funding for charging infrastructure is not predetermined by any specific approach to constructing infrastructure. Rather, the approach encourages charging innovations that are best fit for unique settings while maintaining efficiency, safety, and grid

---

<sup>172</sup> Formerly known as the Transportation Electrification Regulatory Policies Act (TERPA)

integration standards described above. Funding amounts would be assessed primarily on costs to the user and the ability to meet charging needs. Public funding could be optimized for the most cost-effective solution. This approach also allows costs to “float” according to the market served to ensure enough investment in harder-to-reach customers (such as disadvantaged communities or rural areas).<sup>173</sup>

The principles of the model have the potential to leverage existing public, ratepayer, and other funding sources in a way that can open private investment channels. Several stakeholders, including multiple EVSPs<sup>174</sup>, have expressed interest in or support for this model, while some have expressed uncertainty over the related complexity relative to other programs. CEC staff will continue to seek feedback on this approach and look ahead toward opportunities for the potential testing of the elements of the model in programs and projects.

The CEC has requested proposals for a variety of financing mechanisms with the goal of increasing the rate of private capital to government incentive funds.<sup>175</sup> Experimentation with developers to configure investment programs is critical to understanding the market conditions for expanding infrastructure with less funding from government or utility programs. Some of the potential suggestions that stakeholders have recommended include initiatives to:

1. Structure low-interest revolving loan programs to enable repayment of the principal offered by the state through revenue generated by (or fuel and operational expense savings to) the site.<sup>176</sup> A loan could be complemented with policies that improve the guarantee for a variety of revenue streams (as described above), including increased

---

<sup>173</sup> Further, deployments in equity communities could be exceeded. For example, each bidder could be required to serve at least a certain amount of energy in a socioeconomic- or pollution- geo-targeted area.

<sup>174</sup> See comments from [TURN](#), [Sierra Club](#), [Earth Justice](#), [Center for Sustainable Energy](#), [Enel X](#), [Freewire](#), [Powertree](#), and [EV Charging Association](#) submitted in response to the June 24, 2020 and August 4, 2020 IEPR Workshops on Charging Infrastructure in [Docket 20-IEPR-02](#).

<sup>175</sup> CEC. [Revised Notice of Availability](#), Request for Information - Strategies to Attract Private Investment in Zero Emission Vehicle Charging Infrastructure and Other Clean Transportation Projects – February 2020 and comments of [Clean Energy Works](#) in Docket 20-FINANCE-02.

<sup>176</sup> Princeton Energy Systems. May 13, 2020. Strategies to Attract Private Investment in Zero Emission Vehicle Charging Infrastructure.

<https://efiling.energy.ca.gov/GetDocument.aspx?tn=232972&DocumentContentId=65424>

revenue from properties surrounding the site host.<sup>177</sup> Revenue-based loan repayment could reduce the operating risk of the EVSP, while ensuring that the site developer shares the incentive to hit use targets.

2. Create policies that establish long-term offtake agreements<sup>178</sup> that reduce barriers to high-usage cases (for example, commercial, institutional, or industrial fleets, transportation network company charging<sup>179</sup>) by holistically addressing vehicle purchase, infrastructure installation capital, and operational risks that challenge an EVSP's willingness to engage in project financing.<sup>180</sup>
3. Work with industry to establish consensus "pro forma" standard contracting terms and conditions that enable rapid execution of agreements between infrastructure developers and fully- or partially-subsidized infrastructure programs. One form could include the use of utility tariff on-bill financing in which the utility capitalizes upon an investment in charging infrastructure. The costs of the charging could be recovered through a monthly charge to the EV customer.<sup>181</sup> Alternatively, utilities might enter a long-term,

---

<sup>177</sup> FreeWire Technologies. August 7, 2020. [Strategies to Attract Private Investment in Zero Emission Vehicle Charging Infrastructure.](https://efiling.energy.ca.gov/GetDocument.aspx?tn=234254&DocumentContentId=67099)  
<https://efiling.energy.ca.gov/GetDocument.aspx?tn=234254&DocumentContentId=67099> and Tesla. June 1, 2020. "[Strategies to Attract Private Investment in Zero Emission Vehicle Charging Infrastructure and Other Clean Transportation Projects.](https://efiling.energy.ca.gov/GetDocument.aspx?tn=233272&DocumentContentId=65758)"  
<https://efiling.energy.ca.gov/GetDocument.aspx?tn=233272&DocumentContentId=65758>.

<sup>178</sup> An offtake agreement would define the terms between an electric vehicle service provider and an electric vehicle customer for the respective sale and purchase of the EVSP's product or services. An offtake agreement would be negotiated prior to the construction of the charging facilities to secure future revenues for the EVSP.

<sup>179</sup> Cruise. June 1, 2020. "[Cruise LLC Response to ZEV Charging RFI.](https://efiling.energy.ca.gov/GetDocument.aspx?tn=233262&DocumentContentId=65745)"  
<https://efiling.energy.ca.gov/GetDocument.aspx?tn=233262&DocumentContentId=65745>.

<sup>180</sup> Enel X E-Mobility. April 10, 2020. "Strategies to Attract Private Investment in Zero Emission Vehicle Charging Infrastructure and Other Clean Transportation Projects."  
<https://efiling.energy.ca.gov/GetDocument.aspx?tn=232724&DocumentContentId=64795>

<sup>181</sup> Clean Energy Works. April 10, 2020. "Response to RFI on Strategies to Attract Private Investment in Zero Emission Vehicle Charging Infrastructure and Other Clean Transportation Projects."  
<https://efiling.energy.ca.gov/GetDocument.aspx?tn=232725&DocumentContentId=64796>

fixed-price contracts with standard offer or feed-in-tariffs to enable participation in ancillary services.<sup>182</sup>

4. Coordinate design of incentives with investment state or local tax credits and federal tax credits, advanced technology manufacturing initiatives, and specifically targeted state investments in areas in need of economic recovery, including Qualified Opportunity Zones.<sup>183</sup>

---

<sup>182</sup> Enel X E-Mobility. April 10, 2020. "Strategies to Attract Private Investment in Zero Emission Vehicle Charging Infrastructure and Other Clean Transportation Projects."  
<https://efiling.energy.ca.gov/GetDocument.aspx?tn=232724&DocumentContentId=64795>

<sup>183</sup> Internal Revenue Service. "[Opportunity Zones](https://www.irs.gov/credits-deductions/businesses/opportunity-zones)." <https://www.irs.gov/credits-deductions/businesses/opportunity-zones>.

# CHAPTER 8:

## The Road Ahead

---

Widespread, accessible, and convenient charging infrastructure is critical to transportation electrification and California's ability to address climate change and air pollution. Significant public investment is needed to meet the need for over 1 million shared and public chargers by 2030. Industry, working closely with the CEC, state agencies, and local governments, must quickly close the gap to provide drivers and fleets confidence that their mobility needs can be served by electric vehicles.

This report identifies several actions to support the widespread deployment of charging infrastructure:

1. **Continue public support for charger deployment, using public funds to leverage private funds, and eventually transition to a self-sustaining private market.** The charging market has introduced diverse and novel business models. The state must continue to invest in charging infrastructure deployment in order to achieve its ZEV goals. Public investments in charging infrastructure, including through the successful California Electric Vehicle Infrastructure Project will remain critical to encouraging continued market experimentation, growth, and maturation.
2. **Continue the quantitative modeling efforts to project the quantities, locations, and load curves of chargers needed to meet statewide travel demand, including for MD/HD vehicles.** Work with partner agencies to incorporate updated electrification and vehicle population scenarios as they become available. Communicate results with load-serving entities and other stakeholders to increase efficacy of infrastructure deployment.
3. **Support innovative charging solutions and financing mechanisms.** Explore solutions that can generate new revenue streams, reduce charger costs and improve usage, address the need for grid upgrades, improve resiliency, or be uniquely well-suited to specific environments. Consider innovative financing mechanisms.
4. **Support local efforts to prepare for transportation electrification.** Recognize that there is no one-size-fits-all charger, and local conditions will determine the most appropriate solution. Support local efforts to prepare for transportation electrification, including through community EV blueprints, streamlined permitting ordinances, utility integrated resource plans, and workforce training.
5. **Ensure equitable distribution of charger deployment throughout the State.** Maintain ongoing analyses intended to ensure that chargers are equitably and proportionately deployed throughout the state, such as those called for by Senate Bill 1000.



6. **Align charging with renewable generation and grid needs.** Pursue greater vehicle-grid integration, as charging millions of vehicles will introduce significant new load onto the grid. Smart charging will help automatically align charging with renewable energy generation, and bidirectional technologies will enable vehicles to supply stored electricity to homes, buildings, other vehicles, or the grid to earn revenue.
7. **Prioritize standardized charger connectors and communications protocols.** These standards will promote greater driver convenience, interoperability, and grid-integrated charging at scale.

## GLOSSARY

**ALTERNATING CURRENT (AC)** — Flow of electricity that constantly changes direction. Almost all power produced by electric utilities in the United States moves in current that shifts direction at a rate of 60 times per second.

**BATTERY-ELECTRIC VEHICLE (BEV)** — Also known as an “all-electric” vehicle, BEVs use energy that is stored in rechargeable battery packs. BEVs sustain power through the batteries and therefore must be plugged into an external electricity source to recharge.

**BUILT ENVIRONMENT** — Man-made structures, features, and facilities viewed collectively as the patterns of land use within a community, the design and construction of spaces and buildings within a community, and the transportation systems that connect people to places.<sup>184</sup>

**CALIFORNIA AIR RESOURCES BOARD (CARB)** — The state's lead air quality agency consisting of an 11-member board appointed by the Governor and more than 1,000 employees. CARB is responsible for attainment and maintenance of the state and federal air quality standards, California climate change programs, and motor vehicle pollution control. It oversees county and regional air pollution management programs.

**CALIFORNIA ENERGY COMMISSION (CEC)**—The state agency established by the Warren-Alquist State Energy Resources Conservation and Development Act in 1974 (Public Resources Code, Sections 25000 et seq.) responsible for energy policy. The CEC's five major areas of responsibilities are forecasting future statewide energy needs; licensing power plants sufficient to meet those needs; promoting energy conservation and efficiency measures; developing renewable and alternative energy resources, including providing assistance to develop clean transportation fuels and infrastructure; and planning for and directing state response to energy emergencies.

**CALIFORNIA PUBLIC UTILITIES COMMISSION (CPUC)** — A state agency created by a California constitutional amendment in 1911 to regulate the rates and services of more than 1,500 privately owned utilities and 20,000 transportation companies. The CPUC is an administrative agency that exercises legislative and judicial powers; its decisions and orders may be appealed only to the California Supreme Court. The major duties of the CPUC are to regulate privately owned utilities, securing adequate service to the public at rates that are just and reasonable to customers and shareholders of the utilities; and the oversight of electricity transmission lines and natural gas pipelines. The CPUC also provides electricity and natural gas forecasting, and analysis and planning of energy supply and resources. Its headquarters are in San Francisco.

---

<sup>184</sup> Adapted from the [Oxford University Press](#) and the [California Institute for Local Government](#)

**DIRECT CURRENT (DC)** — A current of electricity that flows in one direction and is the type of power that comes from a battery.

**ELECTRIC VEHICLE (EV)** — A broad category that includes all vehicles that can be fully powered by electricity or an electric motor.

**ELECTRIC VEHICLE CHARGING STATION** — A location where one or more EVSEs are installed to charge EVs.

**ELECTRIC VEHICLE SUPPLY EQUIPMENT (EVSE)** -- Equipment designed to supply power to EVs. Most EVSEs can charge BEVs and PHEVs.

**GREENHOUSE GAS (GHG)** — Any gas that absorbs infrared radiation in the atmosphere. Greenhouse gases include water vapor, carbon dioxide (CO<sub>2</sub>), methane (CH<sub>4</sub>), nitrous oxide (NO<sub>x</sub>), halogenated fluorocarbons (HCFCs), ozone (O<sub>3</sub>), perfluorinated carbons (PFCs), and hydrofluorocarbons (HFCs).

**HYBRID AND ZERO-EMISSION TRUCK AND BUS VOUCHER INCENTIVE PROJECT (HVIP)** — A project launched in 2009 by the CARB in partnership with CALSTART, a transportation nonprofit, to accelerate the purchase of cleaner, more efficient trucks and buses in California.

**KILOWATT (kW)** — One thousand watts, a measure of power. On a hot summer afternoon, a typical home — with central air conditioning and other equipment in use — might have a power demand of 4 kW.

**KILOWATT-HOUR (kWh)** — One kilowatt of electricity supplied for one hour, that is, a measure of energy. It is the most used unit of measure telling the amount of electricity consumed over time.

**MEGAWATT (MW)** — A unit of power equal to 1 million watts.

**NITROGEN OXIDES (OXIDES OF NITROGEN, NO<sub>x</sub>)** — A general term for compounds of nitric oxide (NO), nitrogen dioxide (NO<sub>2</sub>), and other oxides of nitrogen. Nitrogen oxides are typically created during combustion and are major contributors to smog formation and acid deposition. NO<sub>2</sub> is a criteria air pollutant and may result in numerous adverse health effects.

**PLUG-IN ELECTRIC VEHICLE (PEV)** — A general term for any car that runs at least partially on battery power and is recharged from the electricity grid. There are two types of PEVs: pure battery-electric and plug-in hybrid electric vehicles.

**PLUG-IN HYBRID ELECTRIC VEHICLE (PHEV)** — PHEVs are powered by an internal combustion engine and an electric motor that uses energy stored in a battery. The vehicle can be plugged in to an electric power source to charge the battery. Some can travel nearly 100 miles on electricity alone, and all can operate solely on gasoline (like a conventional hybrid).

**SOCIETY OF AUTOMOTIVE ENGINEERS (SAE)** — A global association of more than 128,000 engineers and related technical experts in the aerospace, automotive, and commercial vehicle

industries. It is the leader in connecting and educating mobility professionals to enable safe, clean, and accessible mobility solutions.<sup>185</sup>

**TRANSPORTATION NETWORK COMPANY (TNC)** — A company that provides prearranged transportation services for compensation using an online-enabled application or platform (such as smartphone apps) to connect drivers using their personal vehicles with passengers.

**VEHICLE-GRID INTEGRATION (VGI)** — Methods to align electric vehicle charging with the needs of the electric grid. To do this, electric vehicles must have capabilities to manage charging or support two-way communication between vehicles and the grid.<sup>186</sup>

**ZERO-EMISSION VEHICLE (ZEV)** — Vehicles that produce no emissions from the onboard source of power (for example, hydrogen fuel cell vehicles and electric vehicles).

---

185 [Society of Automotive Engineers](https://www.sae.org/about/) (https://www.sae.org/about/).

186 [California Public Utilities Commission](https://www.cpuc.ca.gov/General.aspx?id=6442454110) (https://www.cpuc.ca.gov/General.aspx?id=6442454110).

# APPENDIX A:

## List of Related Public Workshops

---

March 11, 2019: The CEC, CARB, and CPUC conducted a joint workshop regarding light-duty electric vehicle charging infrastructure needs.<sup>187</sup>

May 2, 2019: The CEC, CARB, and CPUC conducted a joint workshop regarding medium- and heavy-duty, off-road, port and airport charging infrastructure needs.<sup>188</sup>

May 20-21, 2020: The CEC hosted a workshop with stakeholder presentations regarding port and off-road equipment and medium- and heavy-duty vehicles used for moving freight goods and mass transportation.<sup>189</sup>

June 4, 2020: CEC staff hosted a public workshop to solicit feedback on the CEC's proposed methodology and preliminary analysis for the Senate Bill 1000 Electric Vehicle Charging Infrastructure Deployment Assessment.<sup>190</sup>

June 10, 2020: CEC staff hosted a workshop to solicit feedback on methods to count public and shared private electric vehicle chargers in California.<sup>191</sup>

June 22, 2020: The CEC and CPUC conducted a joint workshop regarding vehicle-grid integration and charging infrastructure.<sup>192</sup>

---

187 [March 11 and May 2, 2019, workshop sessions](https://www.energy.ca.gov/data-reports/reports/integrated-energy-policy-report/2019-integrated-energy-policy-report/2019-iepr): <https://www.energy.ca.gov/data-reports/reports/integrated-energy-policy-report/2019-integrated-energy-policy-report/2019-iepr>.

188 Ibid.

189 May 20-21, 2020: workshops [session 1](https://www.energy.ca.gov/event/workshop/2020-05/iepr-commissioner-w%E2%80%A2May%2020-21,%202020orkshop-heavy-duty-zero-emission-vehicle-market-trends)- <https://www.energy.ca.gov/event/workshop/2020-05/iepr-commissioner-w%E2%80%A2May%2020-21,%202020orkshop-heavy-duty-zero-emission-vehicle-market-trends>, [session 2](https://www.energy.ca.gov/event/workshop/2020-05/iepr-commissioner-workshop-heavy-duty-zero-emission-vehicle-market-trends-0)- <https://www.energy.ca.gov/event/workshop/2020-05/iepr-commissioner-workshop-heavy-duty-zero-emission-vehicle-market-trends-0>.

190 [June 4, 2020: workshop](https://www.energy.ca.gov/event/2020-06/senate-bill-1000-workshop)- <https://www.energy.ca.gov/event/2020-06/senate-bill-1000-workshop>.

191 [June 10, 2020: workshop](https://www.energy.ca.gov/event/2020-06/staff-workshop-counting-electric-vehicle-chargers-california)- <https://www.energy.ca.gov/event/2020-06/staff-workshop-counting-electric-vehicle-chargers-california>.

192 [June 22, 2020: workshop session 1](https://www.energy.ca.gov/event/workshop/2020-06/session-1-joint-agency-workshop-vehicle-grid-integration-and-charging)- <https://www.energy.ca.gov/event/workshop/2020-06/session-1-joint-agency-workshop-vehicle-grid-integration-and-charging>.

August 4 and 6, 2020: The CEC, CARB, and CPUC conducted a joint workshop and presented preliminary results on needed chargers, hardware and software, grid capacity analysis, and deployments in low-income communities.<sup>193</sup>

---

193 August 4-6, 2020: workshops [session 1-](https://www.energy.ca.gov/event/workshop/2020-08/session-1-engagement-and-outreach-enhancing-charging-infrastructure) <https://www.energy.ca.gov/event/workshop/2020-08/session-1-engagement-and-outreach-enhancing-charging-infrastructure>, [session 2-](https://www.energy.ca.gov/event/workshop/2020-08/session2-charging-infrastructure-technology-and-markets-commissioner) <https://www.energy.ca.gov/event/workshop/2020-08/session2-charging-infrastructure-technology-and-markets-commissioner>, [session 3-](https://www.energy.ca.gov/event/workshop/2020-08/session3-modeling-and-projecting-charging-infrastructure-commissioner) <https://www.energy.ca.gov/event/workshop/2020-08/session3-modeling-and-projecting-charging-infrastructure-commissioner>, [session 4-](https://www.energy.ca.gov/event/workshop/2020-08/session-4-examining-needs-infrastructure-development-commissioner-workshop) <https://www.energy.ca.gov/event/workshop/2020-08/session-4-examining-needs-infrastructure-development-commissioner-workshop>.

# APPENDIX B:

## EVI-Pro 2 Inputs and Parameters

---

The data below highlights a few of the key inputs and parameters used for the EVI-Pro 2 analysis discussed in this report.

Table B-1 illustrates the share of BEVs and PHEVs in each calendar year from the CEC’s Energy Assessments Division’s Aggressive case for the Transportation Energy Demand Forecast in the 2020 IEPR update. The table displays inputs for the baseline scenario of 5 million ZEVs by 2030. The low scenario (around 2 million ZEVs) results in a 2030 BEV share of 62% and PHEV share of 38%, while the high scenario (around 8 million ZEVs) results in a 70% BEV share and 30% PHEV share.

**Table B-1: BEV/PHEV Shares for 5 Million ZEVs in EVI-Pro 2**

	2020	2021	2022	2023	2024	2025	2026	2027	2028	2029	2030
BEV Share	55%	59%	62%	64%	65%	66%	67%	68%	68%	69%	70%
PHEV Share	45%	41%	38%	36%	35%	34%	33%	32%	32%	31%	30%

Source: CEC and National Renewable Energy Laboratory

Figure B-1 and Figure B-2 show the breakdown of forecasted BEV and PHEV populations by vehicle classification for the baseline scenario of 5 million ZEVs. EVI-Pro 2 simulates seven different vehicle classifications.

**Figure B-1: BEV Population Breakdown by Vehicle Classification for Baseline Scenario (5 Million ZEVs)**

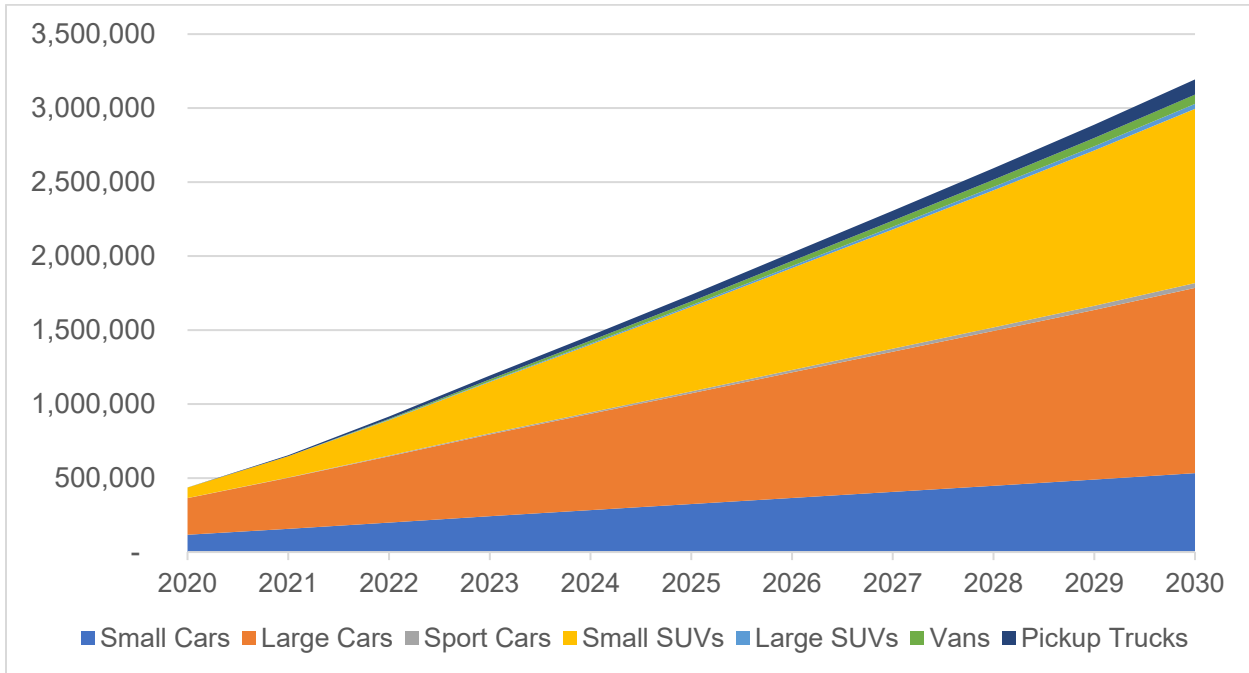

**The BEV forecasts in the CEC’s Aggressive forecast for the 2020 IEPR indicate a market dominated by large cars and small SUVs, which make up a combined 76 percent of the 2030 fleet. Small cars make up 17% of the fleet, while the remaining vehicle classifications make up a combined 7% of the fleet.**

Source: CEC



**Figure B-2: PHEV Population Breakdown by Vehicle Classification for Baseline Scenario (5 Million ZEVs)**

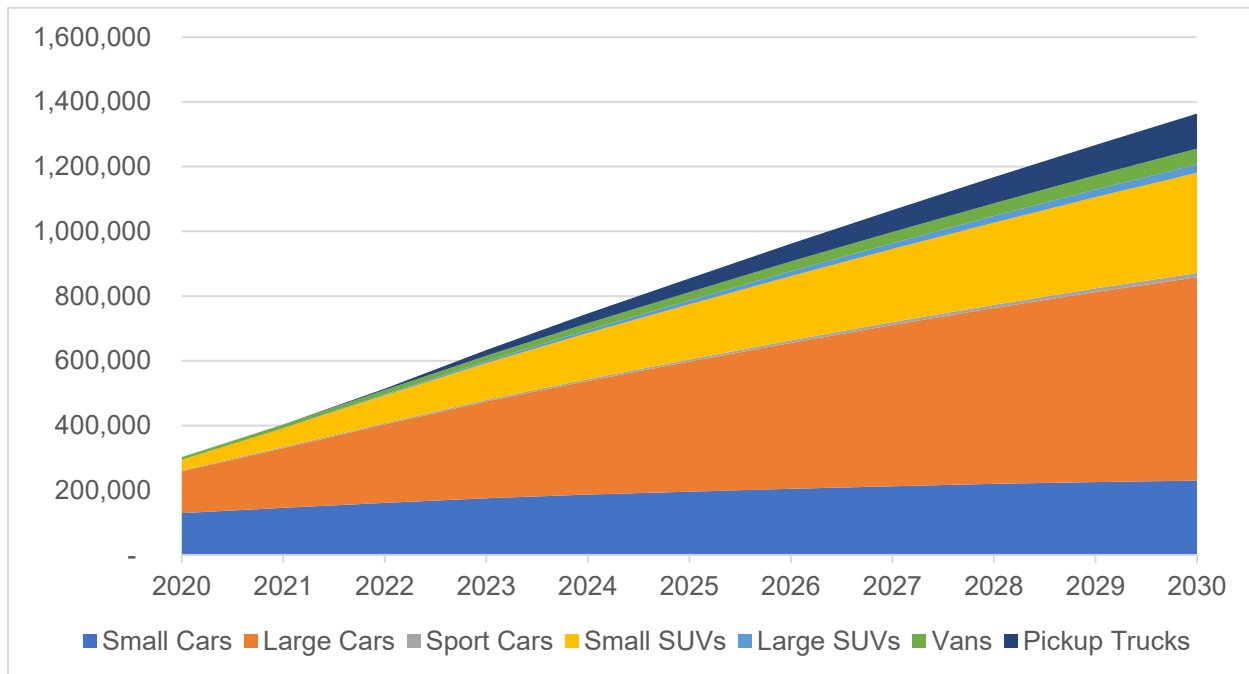

The PHEV forecasts in the CEC’s Aggressive forecast for the 2020 IEPR indicate a market dominated by large cars comprising 46 percent of the 2030 fleet. This is followed by small SUVs and small cars, which make up 23 percent and 17 percent, respectively, of the 2030 fleet. Over the course of the decade, other vehicle classes gain some ground, most notably pickup trucks, which grow from 0 percent to 8 percent of the fleet from 2020 to 2030.

Source: CEC

Table B-2 and Table B-3 show the electric range values for BEVs and PHEVs, respectively, by vehicle classification and simulation year. It is important to note that these values are “on the road” fleet averages in each year. In addition, a zero in the table indicates that there are no vehicles in that classification forecasted to be on the road in that year. For example, Table B-2c shows that there are no BEV pickup trucks forecasted in 2020 because the electric range equals zero. The electric ranges are the same for both the baseline (5 million ZEVs) and high (around 8 million ZEVs) scenarios.

**Table B-2: Electric Range for BEVs by Vehicle Classification and Simulation Year**

Electric Range (miles)	2020	2021	2022	2023	2024	2025	2026	2027	2028	2029	2030
Small Cars	101	104	108	111	113	114	116	118	121	123	127
Large Cars	291	292	293	294	294	295	295	296	296	297	298

Sport Cars	224	301	317	325	331	336	340	344	347	350	353
Small SUVs	294	310	313	317	320	322	324	326	328	329	327
Large SUVs	142	144	143	143	143	144	145	147	149	151	154
Vans	128	128	133	134	134	134	135	136	138	140	143
Pickup Trucks	0	169	168	168	168	168	168	170	172	174	177

Source: CEC and National Renewable Energy Laboratory

**Table B-3: Electric Range for PHEVs by Vehicle Classification and Simulation Year**

Electric Range (miles)	2020	2021	2022	2023	2024	2025	2026	2027	2028	2029	2030
Small Cars	38	38	38	38	38	39	39	39	39	39	39
Large Cars	19	20	21	21	21	22	22	22	22	22	23
Sport Cars	18	18	18	19	19	19	19	19	19	19	19
Small SUVs	43	43	44	45	45	46	47	47	48	48	49
Large SUVs	0	39	39	39	39	39	39	39	40	40	40
Vans	39	38	38	38	37	37	37	37	37	38	38
Pickup Trucks	0	45	46	46	46	46	46	46	46	46	47

Source: CEC and National Renewable Energy Laboratory

Table B-4 and Table B-5 show the battery size for BEVs and PHEVs, respectively, by vehicle classification and simulation year. The battery sizes are the same for both the baseline (5 million ZEVs) and high (around 8 million ZEVs) scenarios.

**Table B-4: Battery Size for BEVs by Vehicle Classification and Simulation Year**

Battery Size (kWh)	2020	2021	2022	2023	2024	2025	2026	2027	2028	2029	2030
Small Cars	29	30	31	32	32	33	33	34	34	34	35
Large Cars	79	79	78	78	78	77	76	76	75	75	75
Sport Cars	94	118	125	127	129	130	132	133	133	134	135
Small SUVs	106	108	106	106	106	106	106	106	106	106	104
Large SUVs	66	65	62	62	62	62	62	63	63	64	65

Vans	49	49	46	46	46	46	46	46	47	47	48
Pickup Trucks	0	76	75	75	74	74	74	75	75	76	77

Source: CEC and National Renewable Energy Laboratory

**Table B-5: Battery Size for PHEVs by Vehicle Classification and Simulation Year**

Battery Size (kWh)	2020	2021	2022	2023	2024	2025	2026	2027	2028	2029	2030
Small Cars	14	14	14	14	14	14	14	14	14	14	14
Large Cars	8	8	8	8	9	9	9	9	9	9	9
Sport Cars	7	7	7	7	7	7	7	7	7	7	7
Small SUVs	17	17	17	18	18	18	18	18	18	18	18
Large SUVs	0	14	14	14	14	14	14	14	14	14	14
Vans	12	11	11	11	11	11	11	11	11	11	11
Pickup Trucks	0	17	17	17	17	17	17	17	17	17	17

Source: CEC and National Renewable Energy Laboratory

Table B-6 and Table B-7 show the residential AC charge power and DC charge power, respectively, for BEVs. It is assumed that the AC charge power for public and workplace charging stays constant at 6.6 kW for all vehicle classifications in all year. Currently, the DC charge powers are derived from charge curves developed for the EVI-RoadTrip analysis. Average DC charge power was estimated through statistical distribution of plug-in and plug-out SOC from EVI-RoadTrip simulations. Future work will aim to develop specific charge curves for the vehicle classifications found in EVI-Pro 2. The charge powers are the same for both the baseline (5 million ZEVs) and high (around 8 million ZEVs) scenarios.

**Table B-6: Residential AC Charge Power for BEVs by Vehicle Classification and Simulation Year**

Charge Power (kW)	2020	2021	2022	2023	2024	2025	2026	2027	2028	2029	2030
Small Cars	5.2	5.4	5.6	5.7	5.8	5.9	6.0	6.1	6.2	6.3	6.5
Large Cars	12.0	12.0	12.0	12.0	12.0	12.0	12.0	12.0	12.0	12.0	12.0
Sport Cars	12.0	12.0	12.0	12.0	12.0	12.0	12.0	12.0	12.0	12.0	12.0

Small SUVs	12.0	12.0	12.0	12.0	12.0	12.0	12.0	12.0	12.0	12.0	12.0
Large SUVs	7.7	7.8	7.8	7.8	7.8	7.8	7.9	8.0	8.1	8.2	8.3
Vans	7.0	7.0	7.2	7.2	7.2	7.3	7.3	7.4	7.5	7.6	7.7
Pickup Trucks	0	9.2	9.1	9.1	9.1	9.1	9.1	9.2	9.3	9.4	9.6

Source: CEC and National Renewable Energy Laboratory

**Table B-7: DC Charge Power for BEVs by Vehicle Classification and Simulation Year**

Charge Power (kW)	2020	2021	2022	2023	2024	2025	2026	2027	2028	2029	2030
Small Cars	23.8	32.1	40.3	48.6	56.9	65.2	73.5	81.8	90.1	98.4	106.6
Large Cars	43.3	58.3	73.4	88.4	103.4	118.5	133.6	148.7	163.7	178.8	193.9
Sport Cars	43.3	58.3	73.4	88.4	103.4	118.5	133.6	148.7	163.7	178.8	193.9
Small SUVs	64.9	79.1	93.2	107.4	121.6	135.8	151.3	166.8	182.3	197.8	213.3
Large SUVs	64.9	79.1	93.2	107.4	121.6	135.8	151.3	166.8	182.3	197.8	213.3
Vans	64.9	79.1	93.2	107.4	121.6	135.8	151.3	166.8	182.3	197.8	213.3
Pickup Trucks	64.9	79.1	93.2	107.4	121.6	135.8	151.3	166.8	182.3	197.8	213.3

Source: CEC and National Renewable Energy Laboratory

Table B-8 shows the AC charge power of PHEVs. It is assumed that residential, public, and workplace charge powers are all the same. The charge powers are the same for both the baseline (5 million ZEVs) and high (around 8 million ZEVs) scenarios.

**Table B-8: AC Charge Power for PHEVs by Vehicle Classification and Simulation Year**

Charge Power (kW)	2020	2021	2022	2023	2024	2025	2026	2027	2028	2029	2030
Small Cars	5.8	5.8	5.9	5.9	5.9	5.9	5.9	5.9	5.9	5.9	5.9
Large Cars	3.5	3.7	3.9	3.9	4.0	4.0	4.1	4.1	4.1	4.2	4.2
Sport Cars	3.5	3.5	3.6	3.6	3.7	3.7	3.7	3.7	3.7	3.8	3.8
Small SUVs	5.1	5.2	5.3	5.3	5.4	5.5	5.6	5.6	5.7	5.7	5.8
Large SUVs	0.0	4.7	4.8	4.8	4.8	4.8	4.8	4.8	4.8	4.8	4.9

Vans	4.7	4.6	4.6	4.6	4.6	4.5	4.5	4.5	4.5	4.6	4.6
Pickup Trucks	0.0	5.4	5.5	5.5	5.5	5.5	5.5	5.6	5.6	5.6	5.7

Source: CEC and National Renewable Energy Laboratory

Finally, the charger utilization assumptions have been changed in this analysis compared to earlier results. Before, higher bounds for infrastructure were based on utilization rates of 1 event per Level 2 plug per day and 6 events per DC fast charger plug per day and lower bounds were based on utilization rates of 2 events per Level 2 plug per day and 9 events per DC fast charger plug per day. This resulted in a large range between upper and lower bounds for plug counts for previous analyses.

In these updates, network size for non-residential Level 2 and DC fast charging is calculated as a function of simulated charging demand using results of linear regression analysis that leveraged over 5 million observed charging events from EVSPs operating in California. Network size is estimated based on the number of observed charging events per month along with county-specific socioeconomic variables such as population and income level. The model identifies a strong correlation between the supply of infrastructure and charging demand, resulting in statewide averages of close to 1 event per Level 2 plug per day and over 8 events per DC fast charger plug per day in 2030. It is important to note that these are statewide averages, and county-level variation for charger utilization is observed and will be incorporated in future analysis. The lower and upper bounds for statewide average charger utilization used in EVI-Pro 2 are determined through the confidence intervals from this regression analysis. These refined charger utilization inputs result in a narrower gap between the lower and upper bounds for EVI-Pro 2 plug counts provided in Chapter 4 and Appendix C.

# APPENDIX C:

## EVI-Pro 2 Alternative Futures Scenarios

---

As described in Chapter 4, there are three primary scenarios for EVI-Pro 2. The main difference between these scenarios is the ZEV fleet size. Otherwise, the EVI-Pro 2 inputs, assumptions, preferences, and methodologies in these three scenarios are dubbed the “business as usual” case. However, staff also investigated “alternative future” scenarios, which each make a single adjustment to the assumptions or preferences in EVI-Pro 2. These scenarios, described in Table C-1, are meant to illustrate potential futures given the uncertainty of how the electric transportation landscape may evolve in the next decade.

**Table C-1: Summary of Alternative Future Scenarios**

Scenario	EVI-Pro 2 Modification Compared to Business as Usual
Business as Usual	None
Unconstrained	No TOU participation is assumed (and thus no midnight timed charging)
Gas Station Model	Only 40% of vehicles have access to overnight charging
Level 1 Charging	Level 1 charging is additionally enabled as an option for public and workplace charging
PHEV eVMT Maximization	PHEVs are forced to charge at every stop

Source: CEC

Table C-2 highlights the network results for the alternative future scenarios to compare against the business as usual case. These results are for the baseline fleet size of 5 million ZEVs.

**Table C-2: Alternative Future Network Results for 5 Million ZEVs in 2030**

	Business as Usual	Unconstrained	Gas Station Model	Level 1 Charging	PHEV eVMT Maximization

Plug Type	(1000 plugs)		(1000 plugs)		(1000 plugs)		(1000 plugs)		(1000 plugs)	
	Low	High	Low	High	Low	High	Low	High	Low	High
MUDs (Level 1+2)	181	223	181	223	41	51	181	223	181	223
Work (Level 1)	0	0	0	0	0	0	238	252	0	0
Work (Level 2)	335	355	335	355	422	447	196	208	384	407
Public (Level 1)	0	0	0	0	0	0	364	385	0	0
Public (Level 2)	375	397	375	397	433	458	162	171	435	461
All Level 1 and 2	891	975	891	975	896	956	1,141	1,239	1,000	1,091
Public (DC fast chargers)	30.5	32.1	30.5	32.1	51.2	53.9	25.4	26.8	30.1	31.8
Total Chargers	921.5	1,007	921.5	1,007	947	1,010	1,166	1,267	1,030	1,123

Source: CEC and National Renewable Energy Laboratory

As the results show, the business as usual case results in the smallest total charging network. The unconstrained scenario results in the same exact network as the business as usual case, because the elimination of TOU participation only affects the load profile at this time. Future work will aim to characterize the choice between Level 1 and Level 2 charging with TOU participation, which should lead to differences in the network results. The gas station model results in the second smallest total charging network, although it contains the highest number of DC fast chargers (about 20,000 more than the business as usual case). The Level 1 charging scenario results in the largest network size, due to the numerous Level 1 chargers that are required to meet travel and charging demand. The PHEV eVMT maximization scenario results in the second-largest network size, due to the increased public and workplace Level 2 chargers that are required to meet the charging constraints in this scenario. It is important to note that the multi-unit dwelling infrastructure requirements only change in the gas station model, because this is the only scenario where the assumption of residential charging access is modified. Otherwise, all of the other alternative futures keep the same residential charging access as the business as usual case, so only the public and workplace network changes.

Shown below are 2030 weekday load curve results for the alternative future scenarios. As stated above, these results are for a fleet size of 5 million ZEVs by 2030.

Figure C-1 shows the unconstrained load profile. As mentioned before, the only difference in this scenario compared to the business as usual case is the shift in residential charging load. The unconstrained case assumes no TOU participation, and thus no timed charging at midnight. As a result, the load profile shows an evening ramp in residential charging starting at 4 p.m. and peaking around 8 p.m. This unconstrained load profile shape is very similar to the original EVI-Pro 1 load profile and the EVI-Pro 2 preliminary results shown at the CEC’s August 6<sup>th</sup> IEPR workshop.

**Figure C-1: Projected 2030 Weekday Load Curve for the Unconstrained Alternative Future**

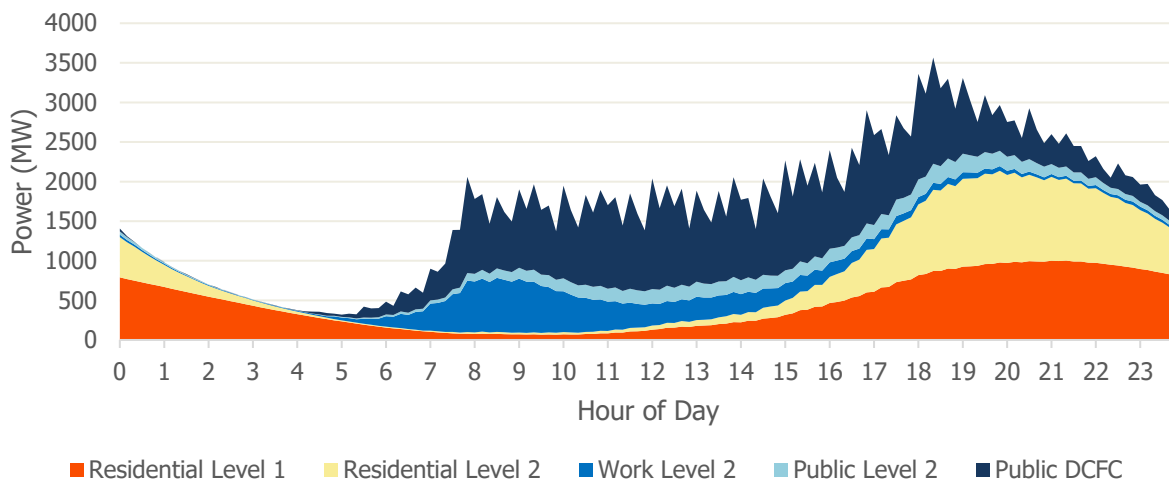

**The unconstrained scenario results in a load profile similar to previous EVI-Pro results, with an evening ramp in residential charging starting around 4 p.m. and peaking around 8 p.m. in 2030. The lack of TOU participation in this scenario removes the midnight timed charging peak.**

Source: CEC and National Renewable Energy Laboratory

Figure C-2 shows the gas station model load profile. The decrease in residential charging access from 72% to 40% results in a dramatically increased daytime DC fast charging load compared to the business as usual case, spiking to over 3 GW at certain times. Meanwhile the



midnight residential charging peak drops by over 1.5 GW. This scenario highlights the potential need for fast charging to provide a replacement for home charging, emulating the conventional gas station business model seen today.

**Figure C-2: Projected 2030 Weekday Load Curve for the Gas Station Model Alternative Future**

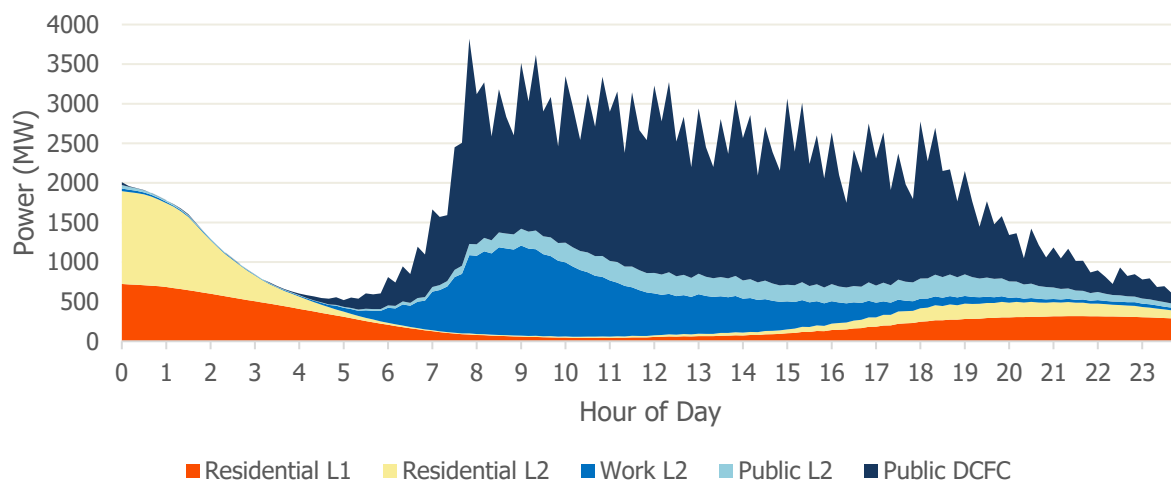

**The gas station model results in a significant increase in daytime DC fast charging load, peaking at nearly 4 GW at 8 a.m. in 2030. The midnight residential charging peak in turn decreases by about 1.5 GW.**

Source: CEC and National Renewable Energy Laboratory

Figure C-3 shows the Level 1 charging load profile. The load profile illustrates that public and workplace Level 1 charging can accommodate low-energy charging sessions, but this represents a relatively small portion of the total load. While the network results in Table C-2 showed that the public and workplace Level 2 infrastructure could be roughly halved compared to the business as usual case, it requires even more Level 1 chargers, resulting in the largest network of the alternative future scenarios. This type of scenario could result in an inefficient network to meet the travel and charging demands of drivers.

**Figure C-3: Projected 2030 Weekday Load Curve for the Level 1 Charging Alternative Future**

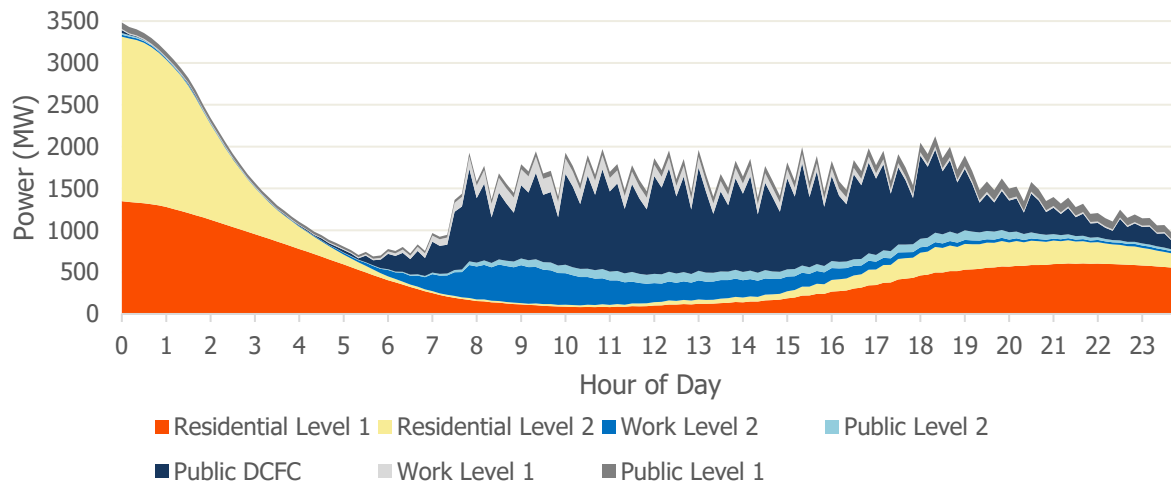

**The load profile for the Level 1 charging scenario demonstrates that Level 1 charging largely accommodates low-energy charging sessions and does not make up a large portion of the total load. This Level 1 load primarily consists of workplace charging during the day before switching over to primarily public Level 1 charging in the evening.**

Source: CEC and National Renewable Energy Laboratory

Figure C-4 shows the PHEV eVMT maximization load profile. Interestingly, this load profile results in negligible differences compared to the business as usual case, despite increasing the public and workplace Level 2 charging network by about 100,000 plugs. This effect is likely due to the fact that PHEVs have low-energy charging session due to their small battery sizes. The constraint of forcing PHEVs to charge at every stop therefore results in an inefficient Level 2 network that results in small gains in electricity consumption.

**Figure C-4: Projected 2030 Weekday Load Curve for the PHEV eVMT Maximization Alternative Future**

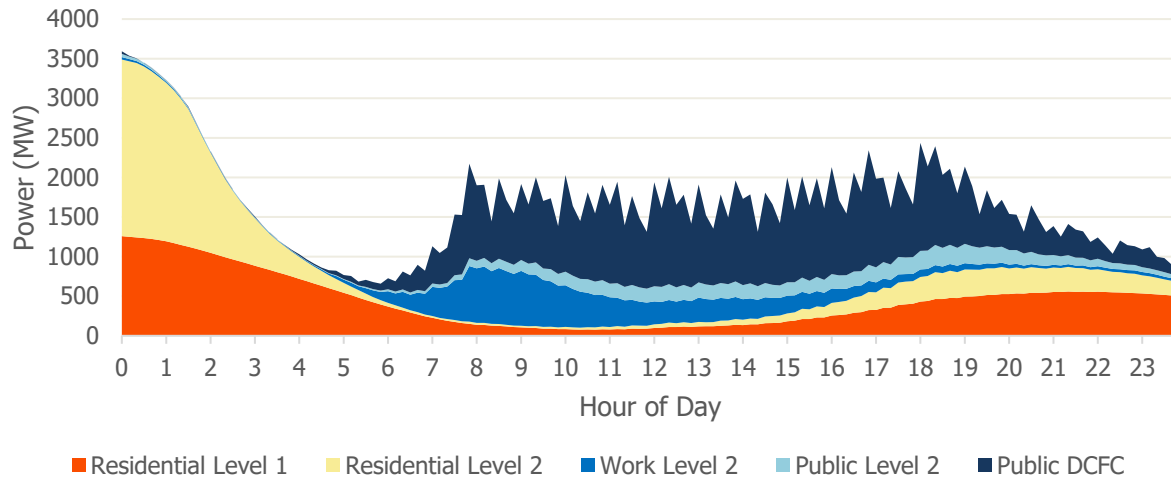

**The PHEV eVMT maximization scenario results in an almost identical load profile compared to the baseline case. This indicates that forcing PHEVs to charge at every stop does not make a significant impact on the load profile, likely due to the low-energy charging of these vehicles, and ultimately results in an inefficient infrastructure network.**

Source: CEC and National Renewable Energy Laboratory